

LCA20

Load Cell Amplifier

User Manual
mantracourt.com

ME mantracourt

Contents

LCA20 User Manual	5
Overview	5
Backwards Compatibility	5
New Features	6
How to Use This Manual	7
Using the Wired Handheld Programmer/Display	8
Overview	8
Keypad and Display	8
LCA15 Legacy Mode	9
Keys	9
Menus	9
Password Protection	10
Menu Tables	11
Password Level 1	11
Password Level 2	14
Password Level 3	15
LCA20 Mode	18
Keys	18
Menus	18
Password Protection	19
Menu Tables	19
Auto Calibration	26
Procedure	26
Notes on Auto calibration	27
MVV Source Calibration	27
Using the LCA Toolkit Software	29
What Can It Do?	29
Using the Software	29
Home Page	30
Information	32
Save & Restore	34
Trend Chart	35
Logging	36
Analogue Outputs	39
Relays	42
Measurement	43
Communications	45
Digital Inputs	46
Calibration	47
Automatic Tab	48
Table Tab	49
Advanced Tab	50
Shunt Calibration Tab	51
Cal Info Tab	52
Filters	53
Communications Protocols for Custom Software & Data Acquisition	54
Communication Port	54
Protocols	54
Software Command Reference for MantraBus2, Modbus and MantraASCII	55
Multiple-Option Selection Table	58
MantraBus1	59
Operation	59
Writing to Parameters	59
Command Table	59
Command 1 (Read All)	60
Command 2 (Read Net)	61
Write Commands	61
Response to Write Commands	62
EEPROM commands	63
Write Commands That Perform Actions	64
MantraBus2	66
Framing Character	66
Checksum	66
Data Transfer	66
Floating-Point Data Format	66
End of Data Identifier	67
ACK & NAK	67
Writing to Parameters	67
Reading of Parameters	68
Action Commands	68
Modbus	69
Modbus Messages	69
Parameter Addresses	69

Parameter Values	69
Error Codes.....	70
Write Command Example	70
Read Command Example	71
Execute Command Example	71
MantraASCII2	72
Host Command Message Format	72
Slave Response Message Formats	73
Write Command.....	73
Read Command.....	74
Action Command.....	74
Broadcast Commands.....	74
Bad Commands	75
Using a Printer or Remote display	75
Selecting the Printer functions.....	75
Label Parameter	76
Format of Output String.....	77
Installation	78
Mechanical	78
LCB20 Board Module	78
LAC ABS Case.....	79
LTL Transparent Lid.....	79
LSS Stainless Steel Case	80
LDC Die Cast Case	81
D2 DIN Rail	82
Connections.....	83
Programmer Modules.....	83
LP1.....	83
LP2.....	83
Power Supplies.....	84
LS1 Mains Supply	84
Fitting Module to Main Board.....	84
Supply Connections.....	85
97VAC to 120VAC.....	85
210VAC to 260VAC	85
LS3 DC Supply	86
Fitting Module to Main Board.....	86
Supply Connection	87
Load cell Connections.....	87
Connector Location.....	88
4 Wire	88
6 Wire	89
Barriers.....	90
Digital Inputs.....	91
Connector Location.....	91
Connections	91
Analogue Output.....	92
Connector Locations.....	92
Voltage	92
Current	93
Relay Module LR1.....	94
Fitting Module to Main Board.....	94
Contact Connections	94
Communications Module LC4.....	95
Fitting Module to Main Board.....	95
RS232	95
RS422 and RS485 4 Wire	96
Multi-drop Connections.....	96
RS485 2 Wire	97
Multi-drop Connections.....	97
Printer.....	97
Programming Cable PGM1	98
Driver Settings	98
Serial / USB Convertors.....	100
RS232	100
RS485	100
Driver Settings	101
LED Indicator	102
Push Switch SW.....	103
Appendix A - Calibration.....	104
Best practices	104
Table Calibration Method.....	104
mV Source Calibration.....	104
Vref	105
Shunt Calibration.....	105
Using Shunt Calibration.....	106
Appendix B - Measurement.....	107

Overview	107
Zero Tracking	110
System Zero	110
Auto Tare	110
Filters	110
Overview	110
Simple Block Averaging	111
Dynamic Digital Low Pass Filter	111
Peak and Valley Values	113
Snap Command	114
Appendix C - Relays	115
Overview	115
Source	115
Setpoints	115
Inflights	116
Hysteresis	116
Inversion	116
Latching	116
Appendix D - Analogue Output	117
Overview	117
Source	117
Scaling	117
User Adjustment	119
Output Override	119
Appendix E - Digital Inputs	120
Overview	120
Digital Input selection table	120
Appendix F - Security Locking	121
Menu Passwords	121
Handheld/Display Calibration Lock	121
LCA Toolkit Lock	122
Appendix G - Manual Connect	123
Specifications	124
Electronics	124
Loadcell Input	124
Analogue Output	124
Power Supply (LS1, LS3)	125
Relays (LR1)	125
Communications (LC4)	125
Environmental	125
Regulatory	125
CE Approvals	125
European EMC Directive	125
Low Voltage Directive	125
Troubleshooting	126
General connection and setup parameters. - No display on power up	126
Display shows (-1 or 1) continually, without a weight applied to the Strain Gauge	126
Display over ranges (-1 or 1) when, or before, the maximum required weight is applied to the Strain Gauge	126
Display very noisy	126
Display operating in wrong direction	126
Unit will not auto calibrate	126
Relay module: incorrect relay operation	126
No communications	126
Order Codes	127
Accessories	127
Configuration Record Sheet	128
LCA15 Mode	128
Password Level 1	128
Password Level 2	128
Password Level 3	129
LCA20	130
Warranty	132

LCA20 User Manual

Overview

The LCA20 In-Line Intelligent Strain Gauge Amplifier is a compact microprocessor-based unit specifically designed to control and monitor weighing applications. Its flexibility of design allows for the connection of most load cells and pressure or strain gauges over a wide range of sensitivities. Housed in a light grey, ABS case, it is sealed to IP65 standard to meet most environmental conditions.

The LCA20's predecessor, the LCA15 was designed in 1992 with over 10,000 units being sold. It has obtained a well-earned reputation for being a reliable, easy to use and adaptable instrument. The LCA15 has been redesigned as the LCA20 to take advantage of technology that leads to improved performance, increased functionality and the ability to maintain the selling price.

The basic unit offers the following facilities:-

A simple auto calibration of the highest and lowest weights required, an easy auto tare setting and a peak hold and valley facility. A menu password protects the configuration parameters.

DC analogue outputs of 4-20mA and 0-10V are standard with full scaling over any desired range and the ability to invert these outputs if required.

Gain sensitivity is available in two ranges, 0.5 to 3.7mV/V and 3.7 to 7.8mV/V.

Several 'plug in' options are available. A relay module offers two switched set points which can be inverted and/or latched. Hysteresis can be applied to both set points together with individual In-Flight compensation. Both the relay and the Analogue Output have a high level of electrical isolation. A communications module is available as an option and enables RS232, RS422 or RS485 connection to a printer, PC or PLC thus allowing the measurement values to be viewed and any configuration parameters changed. Baud rates between 2400 and 115200 are available.

Internal parameters can be set digitally in real engineering terms by means of an optional plug-in programmer unit or integral display module.

Various power supply options are available, 220/240V AC, 110/120V AC and 9-32V DC.

The LCA20 is also available in IP65 die cast and stainless steel cases for harsh environments while the LCB20 is a PCB-only Eurocard version for customer's own enclosure.

Backwards Compatibility

One of the design criteria for the LCA20 is that it should look and feel the same and be backwards compatible with the LCA15 wherever possible. Existing users will find the same basic menu structure, overall functionality and plug-in modules (with the exception of the communications module) that they are familiar with.

New Features

The main change is with the microprocessor. Using the latest RISC technology, the number of support components required by the processor is reduced and allows the device to run faster giving more processing power.

New features are made possible such as programming the baud rate using the keypad or the communications interface. The Baud rate in the LCA15 had to be set manually by gaining access to jumper links on the communications module. Another benefit of the higher clock rate is the ability to speed up the response of the Analogue Output due to higher PWM frequencies being available. Other benefits from the new processor include in-field re-programming of the device; on-site firmware upgrades are now possible. With more code space and memory available more functionality can be offered such as nine-point linearisation, low pass filtering, programmable digital inputs and self-diagnostics.

The load cell input design has also taken advantage of new technology in the form of the delta-sigma 20 bit ADC. This device has a built-in low temperature drift, low noise amplification stage with switchable gain leading to a much improved measurement performance over the LCA15. The DIL switch fitted to the LCA15 for mV/V selection is no longer required as the two ADC gain ranges cover from 0.5mV/V to 7.8mV/V sensitivities. The appropriate range is selected from the Keypad or communications bus removing the need to gain access to the electronics.

As with the majority of Mantracourt's instrument range the excitation voltage has been decreased to 5V thus allowing for easier barrier selection and the drive capability for up to ten 350 ohm load cells connected in parallel.

The LCA20 is factory calibrated in mV/V terms to within 0.05% FS, this allows table entry of calibration data straight from a load cell test certificate bringing it in line with other Mantracourt instruments. An advantage of a factory calibration is that units can be swapped in the field by copying across the calibration from one unit to another with calibration accuracy maintained at 0.05%FS

The LCA15 has a variant known as LCA15F. This is an LCA15 with a 'Fast' 100 Samples per seconds (SPS) measurement rate. LCA20 has two speeds of measurement, 10SPS and 80SPS so now the new version can be used in more dynamic applications requiring only one module to be stocked.

How to Use This Manual

There are three ways you may want to use the LCA20 and this manual has been arranged to best allow the information required to be presented without having to read irrelevant information.

The three ways to interact with the LCA20 are as follows:

- Handheld programmer/display
- LCA Toolkit software
- Writing your own communications software

It may be that only one of the above methods is used or it may be possible that you will need to refer to more than one section.

For example, you may use the LCA20 in LCA15 compatibility mode and configure and calibrate the module using the handheld programmer/display then use the analogue output functionality. You would not need the other sections.

However, you may use the LCA20 Toolkit to configure and calibrate the module but once configured you connect to it using your own software. In this case two sections are relevant.

Where these sections refer to complex operations or subjects, you will find the detailed information in the Appendices. These can be viewed as required and are independent of the methods you use to configure or communicate with the module.

Using the Wired Handheld Programmer/Display

Overview

The LCA20 can be operated in two modes, LCA15 which is the legacy mode which gives a simple linear menu system or LCA20 mode which has a multi-level menu system. Both modes have 3 password levels and depending on what password has been entered alters what can be accessed, the higher the level of password the more parameters can be accessed.

The keypad and menu system operates for the two different modes and these are described in the next sections of this manual.

Keypad and Display

The Programmer Unit - Is a small hand held unit together with a 2 metre connection lead known as LP2 which plugs into a FFC68 socket on the main assembly board. There is also an option for a permanent field programmer fitted internally which is known as LP1.

All user controls, displays and indicators are mounted on the front panel which comprises a 4.5 digit LCD display and four flush mounted keys.

A flashing '←' symbol in the top left hand corner of the display indicates programming mode. This symbol is also used to indicate there is a load cell integrity issue or that Shunt-Cal is switched on.

Unit Panel Layout

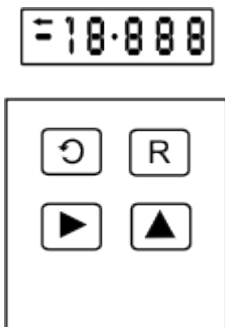

LCA15 Legacy Mode

For backwards compatibility with the LCA15 the traditional single level menu system has been maintained. There are a number of small changes such as item selection using the  key.

Keys



Used to scroll through and change the set up data by displaying mnemonics for each configurable parameter followed by the appropriate data. On reaching the end of the menu "----" is displayed and the module commits any changes made to its non-volatile memory prior to showing the input variable.



Selects the display digit to be modified. The selected digit will flash together with the program indicator. When in programming mode it should be noted that the first digit in the display may not be visible, but the program indicator '←' will flash to indicate that the instrument is in programming mode even though no digits can be seen to be flashing.



Increments each selected display digit 0-9. Pressing the  key under programming conditions will display the leading digit as -, 1, -1, or a blank display for zero.







Additionally, for items that can be selected from a list such as the baud rate **bAud**, then this key cycles through the available options. The currently set value is the first shown data value.



Resets the display to the input variable and enters new data in the LCA20 non-volatile memory.

If, during the programming sequence, selection is not completed, the display will revert to showing the input variable after 2 minutes and any changes made will not be saved



If on pressing the  or  keys after a new value has been entered that is outside the allowed range for that parameter then Err will be displayed until the  or  keys is pressed again. Pressing the  key will exit the menu restoring the last good value to the parameter. Pressing the  key will show the parameters mnemonic again followed by the last good value.

Menus

A series of parameters or programmable functions are provided in the LCA20 to allow the user good flexibility for monitoring and control applications.

These parameters are held as constants in the LCA20's permanent memory and are accessed and checked via the programmer keypad or the communications port.

Data which is entered by the user is retained in EEPROM for up to 10 years without back up power.

New data, when entered, overwrites previous entries when the  key is pressed unless the EEPROM has been disabled via the communications port.

Password Protection

To enter the menu a 4 digit password number must be entered when 'PASS' is displayed. The factory set number, 1111 allows access to the most common parameters.

Additional passwords are required to gain access to the remaining two levels.

Menu Tables

Password Level 1

<i>Item</i>	<i>Range</i>	<i>Default</i>	<i>Description</i>												
PASS	1111	-	Security Password. Correct value required to proceed further.												
SP1	±19999	0000	Desired Set Point trip value for Relay 1												
IF1	±19999	0000	In-Flight compensation for SP1. Relay 1 operates at = (SP1 - IF1)												
SP2	±19999	0000	Desired Set Point trip value for Relay 2												
IF2	±19999	0000	In-Flight compensation for SP2. Relay 2 operates at = (SP2 - IF2)												
HYS	0-19999	0000	Hysteresis amount applied to SP1 and SP2												
OA	0-31	0000	Output Action. The value of OA to be entered is the algebraic sum of the following components:- <table border="1" data-bbox="566 779 1404 1025"> <thead> <tr> <th><i>Selection value</i></th> <th><i>Description</i></th> </tr> </thead> <tbody> <tr> <td>1</td> <td>SP1 Inverted</td> </tr> <tr> <td>2</td> <td>SP2 Inverted</td> </tr> <tr> <td>4</td> <td>AN-OP Inverted</td> </tr> <tr> <td>8</td> <td>SP1 Latched</td> </tr> <tr> <td>16</td> <td>SP2 Latched</td> </tr> </tbody> </table> Example 1: If SP1 needs to be latched and inverted and the analogue output is normal, enter $8 + 1 = 9$	<i>Selection value</i>	<i>Description</i>	1	SP1 Inverted	2	SP2 Inverted	4	AN-OP Inverted	8	SP1 Latched	16	SP2 Latched
<i>Selection value</i>	<i>Description</i>														
1	SP1 Inverted														
2	SP2 Inverted														
4	AN-OP Inverted														
8	SP1 Latched														
16	SP2 Latched														
CALL	±19999	0000	Calibration Low: display value for low calibration point												
CALH	±19999	0000	Calibration High: display value for High calibration point												
At	±19999	0000	Auto Tare value. Value added to Gross to give Net												

<i>Item</i>	<i>Range</i>	<i>Default</i>	<i>Description</i>	
dA		0000	Display Averaging. Number of reading to block average. Resultant samples per second dependant on rATE setting. If rATE is set to 10 samples per second	
			<i>Selection Value</i>	<i>Description</i>
			0	2.5 samples per second
			1	1.25 samples per second
			2	1.6 seconds per sample
			3	3.2 seconds per sample
			4	6.4 seconds per sample
			5	12.8 seconds per sample
			6	25.6 seconds per sample
			7	10 samples per second
			If rATE is set to 80 samples per second	
			<i>Selection Value</i>	<i>Description</i>
0	20 samples per second			
1	10 samples per second			
2	5 samples per second			
3	2.5 samples per second			
4	1.25 samples per second			
5	1.6 seconds per sample			
6	3.2 seconds per sample			
7	80 samples per second			
OPL	±19999	0000	Output Low: display point for minimum Analogue Output	
OPH	±19999	0000	Output High: display point for maximum Analogue Output	
dP	0-5	0002	Decimal point position	
CP	0-133	0000	Communications protocol	
			<i>Selection Value</i>	<i>Description</i>
			0-127	Printer functions
			128	Mantrabus1 *
			131	Mantrabus2 *
			132	Modbus RTU *
			133	MantraASCII2 *
			* Followed by power cycle to implement change	
SdSt	0-254	0001	Serial Device Station number	
bAud		115.2	Baud rate. Selection table	
			<i>Selection value</i>	<i>Description</i>
			2400	2400 baud
			4800	4800 baud
			9600	9600 baud
			19200	19200 baud
			38.4	38400 baud
			57.6	57600 baud
			76.8	76800 baud
			115.2	115200 baud

<i>Item</i>	<i>Range</i>	<i>Default</i>	<i>Description</i>
LAB	0-84	0000	Label/units for Printer. See Using a Printer or Remote Display
Ln	0-19999	0000	Log Number
rS	0-19999	0000	Display Resolution. This value sets the block size that the optional LCD display will increment and decrement by.

Password Level 2

Password level two reveals the parameters associated with the analogue signal path and default display in addition to the above:

<i>Item</i>	<i>Range</i>	<i>Default</i>	<i>Description</i>												
FStP	0-255	0000	RC Filter Steps												
FLVL	0-19999	0000	RC Filter Dynamic Level												
SEnS		0.5-3	Load cell sensitivity <table border="1" data-bbox="582 474 1404 582"> <thead> <tr> <th><i>Selection value</i></th> <th><i>Description</i></th> </tr> </thead> <tbody> <tr> <td>0.5-3</td> <td>0.5 to 3.7 mV/V range</td> </tr> <tr> <td>3.7-7</td> <td>3.7 to 7.8 mV/V range</td> </tr> </tbody> </table>	<i>Selection value</i>	<i>Description</i>	0.5-3	0.5 to 3.7 mV/V range	3.7-7	3.7 to 7.8 mV/V range						
<i>Selection value</i>	<i>Description</i>														
0.5-3	0.5 to 3.7 mV/V range														
3.7-7	3.7 to 7.8 mV/V range														
rAtE		10S	Measurement rate as Samples per Second <table border="1" data-bbox="582 667 1404 775"> <thead> <tr> <th><i>Selection value</i></th> <th><i>Description</i></th> </tr> </thead> <tbody> <tr> <td>10S</td> <td>10 samples per second</td> </tr> <tr> <td>80S</td> <td>80 samples per second</td> </tr> </tbody> </table>	<i>Selection value</i>	<i>Description</i>	10S	10 samples per second	80S	80 samples per second						
<i>Selection value</i>	<i>Description</i>														
10S	10 samples per second														
80S	80 samples per second														
AdCL	±7.8	0000	mV/V Value captured for low calibration point CALL												
AdCH	±7.8	0000	mV/V Value captured for high calibration point CALH												
ZERO	±19999	0000	System Zero Value.												
AOPS	4-20 or 0-10	4-20	Selects Analogue Output, current or voltage												
ddiS		nEt	Selects Defaults display type <table border="1" data-bbox="582 1025 1404 1240"> <thead> <tr> <th><i>Selection value</i></th> <th><i>Description</i></th> </tr> </thead> <tbody> <tr> <td>nEt</td> <td>Net Value</td> </tr> <tr> <td>GroS</td> <td>Gross Value</td> </tr> <tr> <td>PEAK</td> <td>Peak Value</td> </tr> <tr> <td>VALY</td> <td>Valley Value</td> </tr> <tr> <td>SNAP</td> <td>Snap (Held) value</td> </tr> </tbody> </table>	<i>Selection value</i>	<i>Description</i>	nEt	Net Value	GroS	Gross Value	PEAK	Peak Value	VALY	Valley Value	SNAP	Snap (Held) value
<i>Selection value</i>	<i>Description</i>														
nEt	Net Value														
GroS	Gross Value														
PEAK	Peak Value														
VALY	Valley Value														
SNAP	Snap (Held) value														

Menu items from Password 1 follow on from this menu.

Password Level 3

Password level three gives access to the parameters associated with the Analogue Output, Relays and Digital Input options:

<i>Item</i>	<i>Range</i>	<i>Default</i>	<i>Description</i>	
dIP1		Prnt	Digital Input 1 function	
			<i>Selection value</i>	<i>Description</i>
			At	Perform Tare
			Lr	Latch Relay Reset
			Prnt	Do Print
			dEFt	Display Default display set by "ddiS"
			GroS	Display Gross value
			nEt	Display Net value
			PEAK	Display Peak value
			VALY	Display Valley value
			SNAP	Display Snap (Held) value
			PV-r	Peak & Valley Reset
			SCon	Shunt-Cal On
			SCoF	Shunt-Cal Off
dIP2		Latch Relay Reset	Digital Input 2 function	
			<i>Selection value</i>	
			<i>Description</i>	
			At	
			Lr	
			Prnt	
			dEFt	
			GroS	
			nEt	
			PEAK	
			VALY	
			SNAP	
			PV-r	
			SCon	
			SCoF	
			SCTG	
			dSnP	

<i>Item</i>	<i>Range</i>	<i>Default</i>	<i>Description</i>	
dIP3		Auto-Tare	Digital Input 3 function	
			<i>Selection value</i>	<i>Description</i>
			At	Perform Tare
			Lr	Latch Relay Reset
			Prnt	Do Print
			dEFt	Display Default display set by "ddiS"
			GroS	Display Gross value
			nEt	Display Net value
			PEAK	Display Peak value
			VALY	Display Valley value
			SNAP	Display Snap (Held) value
			PV-r	Peak & Valley Reset
			SCon	Shunt-Cal On
			ScoF	Shunt-Cal Off
SCTG	Shunt-Cal Toggle on/off			
dSnP	Do Snap (Hold current value)			
rLS1		nEt	Sets what Value the relay 1 operates from	
			<i>Selection value</i>	<i>Description</i>
			nEt	Net Value
			GroS	Gross Value
			PEAK	Peak Value
			VALY	Valley Value
rLS2		nEt	Sets what Value the relay 2 operates from	
			<i>Selection value</i>	<i>Description</i>
			nEt	Net Value
			GroS	Gross Value
			PEAK	Peak Value
			VALY	Valley Value
AnOP		nEt	Sets what Value the Analogue Output operate from	
			<i>Selection value</i>	<i>Description</i>
			nEt	Net Value
			GroS	Gross Value
			PEAK	Peak Value
			VALY	Valley Value
4.20G	0.9 to 1.025	1.0	User adjustment for 4-20mA gain. Replace function of the LCA15 gain potentiometer. Unit gain = 1.0	
4.20o	-1000 to 1000	0	User adjustment for 4-20mA offset. Replace function of the LCA15 offset potentiometer. Note the value is in PWM counts not mA	
0.10G	0.9- 1.025	1.0	User adjustment for 0-10V gain. Replace function of the LCA15 gain potentiometer. Unit gain = 1.0	
0.10o	-1000 to 1000	0	User adjustment for 0-10V offset. Replace function of the LCA15 offset potentiometer. Note the value is in PWM counts not V	

<i>Item</i>	<i>Range</i>	<i>Default</i>	<i>Description</i>						
OVrV	±19999	19999	Over-range value. The Value at which the display will indicate a Positive over-range condition and force the relays and analogue output to behave accordingly. (Display shows +1)						
undV	±19999	-19999	Under-range value. The Value at which the display will indicate a Negative under-range condition and force the relays and analogue output to behave accordingly. (Display shows -1)						
tYPE		LCA15	<p>Selects the mode in which the LCA operates.</p> <table border="1"> <thead> <tr> <th><i>Selection value</i></th> <th><i>Description</i></th> </tr> </thead> <tbody> <tr> <td>LCA15</td> <td>Restricted functionality as per the original LCA15</td> </tr> <tr> <td>LCA20</td> <td>Full functionality of the LCA20</td> </tr> </tbody> </table>	<i>Selection value</i>	<i>Description</i>	LCA15	Restricted functionality as per the original LCA15	LCA20	Full functionality of the LCA20
<i>Selection value</i>	<i>Description</i>								
LCA15	Restricted functionality as per the original LCA15								
LCA20	Full functionality of the LCA20								

Menu items from Password 2 follow on from this menu.



LCA20 Mode

Keys

The LCA20 has a multilevel menu system. The parameters available are dependent on the password level that has been entered.







 Used to scroll through the menu items available at the current menu level. When a level has been entered that holds parameters then this key scrolls through the parameters available. At this point if the scroll key is not pressed for 3 seconds then the current value of the parameter is displayed.

 Initially used to enter into the next menu level. When displaying a parameter value then this key selects the display digit to be modified. The selected digit will flash together with the program indicator. When in programming mode it should be noted that the first digit in the display may not be visible, but the program indicator '←' will flash to indicate that the instrument is in programming mode even though no digits can be seen to be flashing.

 Used to move up a menu level. If already at the highest menu level **PASS** then the menu system will be exited returning to displaying the input variable. When displaying a parameter value this key increments each selected display digit 0-9. Pressing the  key under programming conditions will display the leading digit as 1, -1, - or a blank display for zero.

Additionally, for items that can be selected from a list such as the baud rate **bAud**, then this key cycles through the available options. The currently set value is the first shown data value.

 Resets the display to the input variable and enters new data in the LCA20 non-volatile memory. If, during the programming sequence no key is pressed the display will revert to showing the input variable after 2 minutes and any changes made will not be saved

 If on pressing the  or  keys after a new value has been entered that is outside the allowed range for that parameter then **Err** will be displayed until the  or  keys is pressed again. Pressing the  key will exit the menu restoring the last good value to the parameter. Pressing the  key will show the parameters mnemonic again followed by the last good value.

Menus

When in LCA20 mode the menu system operates with multiple levels to allow easier navigation round the parameters. Different levels and parameters being made available depending on the

password level entered. There are 3 password levels which can be considered as Operator, Engineer and Configurator/Calibrator.

Password Protection

To enter the menu a 4 digit password number must be entered when 'PASS' is displayed. The factory set number, 1111 allows access to the most common parameters.

Additional passwords are required to gain access to the remaining two levels.

Menu Tables

In the table below the hierarchal level of menu items is indicated by a prefix dot.

<i>Item</i>	<i>Pass Level</i>	<i>Range</i>	<i>Default</i>	<i>Description</i>						
PASS	1	1111		Security Password. Correct value required to proceed further.						
tYPE	3		LCA15	Selects mode of operation. <table border="1" data-bbox="708 801 1423 943"> <thead> <tr> <th><i>Selection value</i></th> <th><i>Description</i></th> </tr> </thead> <tbody> <tr> <td>LCA15</td> <td>Restricted functionality as per the original LCA15</td> </tr> <tr> <td>LCA20</td> <td>Full functionality of the LCA20</td> </tr> </tbody> </table>	<i>Selection value</i>	<i>Description</i>	LCA15	Restricted functionality as per the original LCA15	LCA20	Full functionality of the LCA20
<i>Selection value</i>	<i>Description</i>									
LCA15	Restricted functionality as per the original LCA15									
LCA20	Full functionality of the LCA20									
VALS	1			Values. View generated live values						
GroS	1	-	-	Gross						
nEt	1	-	-	Net						
PEAK	1	-	-	Peak						
VALY	1	-	-	Valley						
SNAP	1	-	-	Snap (Held Value)						
mVV	2	-	-	mV/V						
CALV	2	-	-	Calibrated Value. Gross value before System zero, Zero-Tracking						
rLYS	1			Relay Menu						
rLY1	1			Relay 1 Menu						
SP1	1	±19999	0000	Desired Set Point trip value for Relay 1						
IF1	1	±19999	0000	In-Flight compensation for SP1. Relay 1 operates at = (SP1 - IF1)						
HYS1	1	0-19999	0000	Hysteresis amount applied to SP1						
InV1	1		No	Invert SP1 <table border="1" data-bbox="708 1644 1423 1753"> <thead> <tr> <th><i>Selection value</i></th> <th><i>Description</i></th> </tr> </thead> <tbody> <tr> <td>Yes</td> <td>Inverted SP1 operation</td> </tr> <tr> <td>No</td> <td>Normal SP1 operation</td> </tr> </tbody> </table>	<i>Selection value</i>	<i>Description</i>	Yes	Inverted SP1 operation	No	Normal SP1 operation
<i>Selection value</i>	<i>Description</i>									
Yes	Inverted SP1 operation									
No	Normal SP1 operation									
Ltc1	1		No	Latch SP1 <table border="1" data-bbox="708 1839 1423 1948"> <thead> <tr> <th><i>Selection value</i></th> <th><i>Description</i></th> </tr> </thead> <tbody> <tr> <td>Yes</td> <td>Latching SP1 operation</td> </tr> <tr> <td>No</td> <td>Normal SP1 operation</td> </tr> </tbody> </table>	<i>Selection value</i>	<i>Description</i>	Yes	Latching SP1 operation	No	Normal SP1 operation
<i>Selection value</i>	<i>Description</i>									
Yes	Latching SP1 operation									
No	Normal SP1 operation									

<i>Item</i>	<i>Pass Level</i>	<i>Range</i>	<i>Default</i>	<i>Description</i>												
rLS1	2		nEt	Relay 1 source taken from <table border="1"> <thead> <tr> <th><i>Selection value</i></th> <th><i>Description</i></th> </tr> </thead> <tbody> <tr> <td>nEt</td> <td>Net Value</td> </tr> <tr> <td>GroS</td> <td>Gross Value</td> </tr> <tr> <td>PEAK</td> <td>Peak Value</td> </tr> <tr> <td>VALY</td> <td>Valley Value</td> </tr> <tr> <td>SNAP</td> <td>Snap (Held) value</td> </tr> </tbody> </table>	<i>Selection value</i>	<i>Description</i>	nEt	Net Value	GroS	Gross Value	PEAK	Peak Value	VALY	Valley Value	SNAP	Snap (Held) value
<i>Selection value</i>	<i>Description</i>															
nEt	Net Value															
GroS	Gross Value															
PEAK	Peak Value															
VALY	Valley Value															
SNAP	Snap (Held) value															
rLY2	1	±19999	0000	Relay 2 Menu												
SP2	1	±19999	0000	Desired Set Point trip value for Relay 2												
IF2	1	±19999	0000	In-Flight compensation for SP2. Relay 2 operates at = (SP2 - IF2)												
HYS2	1	0-19999	0000	Hysteresis amount applied to SP2												
InV2	1		No	Invert SP2 <table border="1"> <thead> <tr> <th><i>Selection value</i></th> <th><i>Description</i></th> </tr> </thead> <tbody> <tr> <td>Yes</td> <td>Inverted SP2 operation</td> </tr> <tr> <td>No</td> <td>Normal SP2 operation</td> </tr> </tbody> </table>	<i>Selection value</i>	<i>Description</i>	Yes	Inverted SP2 operation	No	Normal SP2 operation						
<i>Selection value</i>	<i>Description</i>															
Yes	Inverted SP2 operation															
No	Normal SP2 operation															
Ltc2	1		No	Latch SP2 <table border="1"> <thead> <tr> <th><i>Selection value</i></th> <th><i>Description</i></th> </tr> </thead> <tbody> <tr> <td>Yes</td> <td>Latching SP2 operation</td> </tr> <tr> <td>No</td> <td>Normal SP2 operation</td> </tr> </tbody> </table>	<i>Selection value</i>	<i>Description</i>	Yes	Latching SP2 operation	No	Normal SP2 operation						
<i>Selection value</i>	<i>Description</i>															
Yes	Latching SP2 operation															
No	Normal SP2 operation															
rLS2	2		nEt	Relay 2 source taken from <table border="1"> <thead> <tr> <th><i>Selection value</i></th> <th><i>Description</i></th> </tr> </thead> <tbody> <tr> <td>nEt</td> <td>Net Value</td> </tr> <tr> <td>GroS</td> <td>Gross Value</td> </tr> <tr> <td>PEAK</td> <td>Peak Value</td> </tr> <tr> <td>VALY</td> <td>Valley Value</td> </tr> <tr> <td>SNAP</td> <td>Snap (Held) value</td> </tr> </tbody> </table>	<i>Selection value</i>	<i>Description</i>	nEt	Net Value	GroS	Gross Value	PEAK	Peak Value	VALY	Valley Value	SNAP	Snap (Held) value
<i>Selection value</i>	<i>Description</i>															
nEt	Net Value															
GroS	Gross Value															
PEAK	Peak Value															
VALY	Valley Value															
SNAP	Snap (Held) value															
AnOP				Analogue Output Menu												
OPL	1	±19999	0000	Output Low: display point for minimum Analogue Output												
OPH	1	±19999	0000	Output High: display point for maximum Analogue Output												
AnOP	2		nEt	Sets what Value the Analogue Output operates from <table border="1"> <thead> <tr> <th><i>Selection value</i></th> <th><i>Description</i></th> </tr> </thead> <tbody> <tr> <td>nEt</td> <td>Net Value</td> </tr> <tr> <td>GroS</td> <td>Gross Value</td> </tr> <tr> <td>PEAK</td> <td>Peak Value</td> </tr> <tr> <td>VALY</td> <td>Valley Value</td> </tr> <tr> <td>SNAP</td> <td>Snap (Held) value</td> </tr> </tbody> </table>	<i>Selection value</i>	<i>Description</i>	nEt	Net Value	GroS	Gross Value	PEAK	Peak Value	VALY	Valley Value	SNAP	Snap (Held) value
<i>Selection value</i>	<i>Description</i>															
nEt	Net Value															
GroS	Gross Value															
PEAK	Peak Value															
VALY	Valley Value															
SNAP	Snap (Held) value															
AOPS	2		4-20	Selects Analogue Output, current or voltage. <table border="1"> <thead> <tr> <th><i>Selection value</i></th> <th><i>Description</i></th> </tr> </thead> <tbody> <tr> <td>4-20</td> <td>4-20mA current output</td> </tr> <tr> <td>0-10</td> <td>0-10V voltage output</td> </tr> </tbody> </table>	<i>Selection value</i>	<i>Description</i>	4-20	4-20mA current output	0-10	0-10V voltage output						
<i>Selection value</i>	<i>Description</i>															
4-20	4-20mA current output															
0-10	0-10V voltage output															

<i>Item</i>	<i>Pass Level</i>	<i>Range</i>	<i>Default</i>	<i>Description</i>						
InV	2		No	<p>Invert Analogue output. Note this can also be achieved by using OPL greater than OPH.</p> <table border="1"> <thead> <tr> <th><i>Selection value</i></th> <th><i>Description</i></th> </tr> </thead> <tbody> <tr> <td>Yes</td> <td>Inverted analogue output</td> </tr> <tr> <td>No</td> <td>Normal analogue output</td> </tr> </tbody> </table>	<i>Selection value</i>	<i>Description</i>	Yes	Inverted analogue output	No	Normal analogue output
<i>Selection value</i>	<i>Description</i>									
Yes	Inverted analogue output									
No	Normal analogue output									
Adj	3			Adjustment of Analogue output values Menu						
4.20G	3	0.9 to 1.025	1.0	User adjustment for 4-20mA gain. Replace function of the LCA15 gain potentiometer. Unit gain = 1.0						
4.20o	3	-1000 to 1000	0	User adjustment for 4-20mA offset. Replace function of the LCA15 offset potentiometer. Note the value is in PWM counts not mA						
0.10G	3	0.9-1.025	1.0	User adjustment for 0-10V gain. Replace function of the gain LCA15 potentiometer. Unit gain = 1.0						
0.10o	3	-1000 to 1000	0	User adjustment for 0-10V offset. Replace function of the LCA15 offset potentiometer. Note the value is in PWM counts not V						

diSP	1			Display parameters Menu																																				
dA	1		0000	<p>Display Averaging. Number of reading to block average. Resultant samples per second dependant on rATE setting.</p> <p>If rATE is set to 10 samples per second</p> <table border="1"> <thead> <tr> <th>Selection Value</th> <th>Description</th> </tr> </thead> <tbody> <tr> <td>0</td> <td>2.5 samples per second</td> </tr> <tr> <td>1</td> <td>1.25 samples per second</td> </tr> <tr> <td>2</td> <td>1.6 seconds per sample</td> </tr> <tr> <td>3</td> <td>3.2 seconds per sample</td> </tr> <tr> <td>4</td> <td>6.4 seconds per sample</td> </tr> <tr> <td>5</td> <td>12.8 seconds per sample</td> </tr> <tr> <td>6</td> <td>25.6 seconds per sample</td> </tr> <tr> <td>7</td> <td>10 samples per second</td> </tr> </tbody> </table> <p>If rATE is set to 80 samples per second</p> <table border="1"> <thead> <tr> <th>Selection Value</th> <th>Description</th> </tr> </thead> <tbody> <tr> <td>0</td> <td>20 samples per second</td> </tr> <tr> <td>1</td> <td>10 samples per second</td> </tr> <tr> <td>2</td> <td>5 samples per second</td> </tr> <tr> <td>3</td> <td>2.5 samples per second</td> </tr> <tr> <td>4</td> <td>1.25 samples per second</td> </tr> <tr> <td>5</td> <td>1.6 seconds per sample</td> </tr> <tr> <td>6</td> <td>3.2 seconds per sample</td> </tr> <tr> <td>7</td> <td>80 samples per second</td> </tr> </tbody> </table>	Selection Value	Description	0	2.5 samples per second	1	1.25 samples per second	2	1.6 seconds per sample	3	3.2 seconds per sample	4	6.4 seconds per sample	5	12.8 seconds per sample	6	25.6 seconds per sample	7	10 samples per second	Selection Value	Description	0	20 samples per second	1	10 samples per second	2	5 samples per second	3	2.5 samples per second	4	1.25 samples per second	5	1.6 seconds per sample	6	3.2 seconds per sample	7	80 samples per second
Selection Value	Description																																							
0	2.5 samples per second																																							
1	1.25 samples per second																																							
2	1.6 seconds per sample																																							
3	3.2 seconds per sample																																							
4	6.4 seconds per sample																																							
5	12.8 seconds per sample																																							
6	25.6 seconds per sample																																							
7	10 samples per second																																							
Selection Value	Description																																							
0	20 samples per second																																							
1	10 samples per second																																							
2	5 samples per second																																							
3	2.5 samples per second																																							
4	1.25 samples per second																																							
5	1.6 seconds per sample																																							
6	3.2 seconds per sample																																							
7	80 samples per second																																							
dP	1	0-5	0002	Decimal point position																																				
rS	1	0-19999	0000	Display Resolution																																				
ddiS	2		nEt	<p>Selects Defaults display source from</p> <table border="1"> <thead> <tr> <th>Selection value</th> <th>Description</th> </tr> </thead> <tbody> <tr> <td>nEt</td> <td>Net Value</td> </tr> <tr> <td>GroS</td> <td>Gross Value</td> </tr> <tr> <td>PEAK</td> <td>Peak Value</td> </tr> <tr> <td>VALY</td> <td>Valley Value</td> </tr> <tr> <td>SNAP</td> <td>Snap (Held) value</td> </tr> </tbody> </table>	Selection value	Description	nEt	Net Value	GroS	Gross Value	PEAK	Peak Value	VALY	Valley Value	SNAP	Snap (Held) value																								
Selection value	Description																																							
nEt	Net Value																																							
GroS	Gross Value																																							
PEAK	Peak Value																																							
VALY	Valley Value																																							
SNAP	Snap (Held) value																																							
PEAK	2		nEt	<p>SelectsPeak value source</p> <table border="1"> <thead> <tr> <th>Selection value</th> <th>Description</th> </tr> </thead> <tbody> <tr> <td>nEt</td> <td>Net Value</td> </tr> <tr> <td>GroS</td> <td>Gross Value</td> </tr> </tbody> </table>	Selection value	Description	nEt	Net Value	GroS	Gross Value																														
Selection value	Description																																							
nEt	Net Value																																							
GroS	Gross Value																																							
VALY	2		nEt	<p>Selects Valley value source</p> <table border="1"> <thead> <tr> <th>Selection value</th> <th>Description</th> </tr> </thead> <tbody> <tr> <td>nEt</td> <td>Net Value</td> </tr> <tr> <td>GroS</td> <td>Gross Value</td> </tr> </tbody> </table>	Selection value	Description	nEt	Net Value	GroS	Gross Value																														
Selection value	Description																																							
nEt	Net Value																																							
GroS	Gross Value																																							

SNAP	2		nEt	Selects Snap value source. <table border="1"> <thead> <tr> <th>Selection value</th> <th>Description</th> </tr> </thead> <tbody> <tr> <td>nEt</td> <td>Net Value</td> </tr> <tr> <td>GroS</td> <td>Gross Value</td> </tr> </tbody> </table>	Selection value	Description	nEt	Net Value	GroS	Gross Value						
Selection value	Description															
nEt	Net Value															
GroS	Gross Value															
OVrV	3	±19999	19999	Over-range value. The Value at which the display will indicate a Positive over-range condition and force the relays and analogue output to behave accordingly. (Display shows +1)												
undV	3	±19999	19999	Over-range value. The Value at which the display will indicate a Negative under-range condition and force the relays and analogue output to behave accordingly. (Display shows -1)												
LCiP	1			Load cell configuration menu												
FSTP	1	0-255	0000	Low-pass Filter Steps												
FLVL	1	0-19999	0000	Low-pass Filter Dynamic Level												
SEnS	2		0.5-3	Load cell sensitivity <table border="1"> <thead> <tr> <th>Selection value</th> <th>Description</th> </tr> </thead> <tbody> <tr> <td>0.5-3</td> <td>0.5 to 3.7 mV/V range</td> </tr> <tr> <td>3.7-7</td> <td>3.7 to 7.8 mV/V range</td> </tr> </tbody> </table>	Selection value	Description	0.5-3	0.5 to 3.7 mV/V range	3.7-7	3.7 to 7.8 mV/V range						
Selection value	Description															
0.5-3	0.5 to 3.7 mV/V range															
3.7-7	3.7 to 7.8 mV/V range															
rATE	2		10S	Measurement rate 10SPS and 80SPS <table border="1"> <thead> <tr> <th>Selection value</th> <th>Description</th> </tr> </thead> <tbody> <tr> <td>10S</td> <td>10 samples per second</td> </tr> <tr> <td>80S</td> <td>80 samples per second</td> </tr> </tbody> </table>	Selection value	Description	10S	10 samples per second	80S	80 samples per second						
Selection value	Description															
10S	10 samples per second															
80S	80 samples per second															
ACAL	2			Analogue Input Calibration Menu												
AdCL	3	±7.8	0000	mV/V Value captured for low calibration point CALL												
AdCH	3	±7.8	0000	mV/V Value captured for high calibration point CALH												
CALL	2	±19999	0000	Calibration Low: display value for low calibration point												
CALH	2	±19999	0000	Calibration High: display value for high calibration point												
At	2	±19999	0000	Auto Tare value. Value added to Gross to give Net												
trbd	2	±19999	0000	Zero Tracking Band												
ZErO	2	±19999	0000	System Zero												
SErL	1			Serial Port menu												
CP	1		0000	Communications protocol - requires a power cycle <table border="1"> <thead> <tr> <th>Selection Value</th> <th>Description</th> </tr> </thead> <tbody> <tr> <td>0-127</td> <td>Printer functions</td> </tr> <tr> <td>128</td> <td>Mantrabus1</td> </tr> <tr> <td>131</td> <td>Mantrabus2</td> </tr> <tr> <td>132</td> <td>Modbus RTU</td> </tr> <tr> <td>133</td> <td>MantraASCII2</td> </tr> </tbody> </table>	Selection Value	Description	0-127	Printer functions	128	Mantrabus1	131	Mantrabus2	132	Modbus RTU	133	MantraASCII2
Selection Value	Description															
0-127	Printer functions															
128	Mantrabus1															
131	Mantrabus2															
132	Modbus RTU															
133	MantraASCII2															
SdSt	1	0-254	0001	Serial Device Station number												

bAud	1		115.2	Baud rate. Selection table	
				<i>Selection value</i>	<i>Description</i>
				2400	2400 baud
				4800	4800 baud
				9600	9600 baud
				19200	19200 baud
				38.4	38400 baud
				57.6	57600 baud
				76.8	76800 baud
115.2	115200 baud				
LAB	1	0-84	0000	Label/units for Printer. See Using a Printer or Remote Display	
Ln	1	0-19999	0000	Log Number	
dIPS	2			Digital input menu	
dIP1	2		Prnt	Digital Input 1 function	
				<i>Selection value</i>	<i>Description</i>
				At	Perform Tare
				Lr	Latch Relay Reset
				Prnt	Do Print
				dEFt	Display Default display set by "ddiS"
				GroS	Display Gross value
				nEt	Display Net value
				PEAK	Display Peak value
				VALY	Display Valley value
				SNAP	Display Snap (Held) value
				PV-r	Peak & Valley Reset
				SCon	Shunt-Cal On
				SCoF	Shunt-Cal Off
SCTG	Shunt-Cal Toggle on/off				
dSnP	Do Snap (Hold current value)				
dIP2	2		Lr	Digital Input 2 function.	
				<i>Selection value</i>	<i>Description</i>
				At	Perform Tare
				Lr	Latch Relay Reset
				Prnt	Do Print
				dEFt	Display Default display set by "ddiS"
				GroS	Display Gross value
				nEt	Display Net value
				PEAK	Display Peak value
				VALY	Display Valley value
				SNAP	Display Snap (Held) value
				PV-r	Peak & Valley Reset
				SCon	Shunt-Cal On
				SCoF	Shunt-Cal Off
SCTG	Shunt-Cal Toggle on/off				
dSnP	Do Snap (Hold current value)				

dIP3	2		At	Digital Input 3 function.	
				<i>Selection value</i>	<i>Description</i>
				At	Perform Tare
				Lr	Latch Relay Reset
				Prnt	Do Print
				dEFt	Display Default display set by "ddiS"
				GroS	Display Gross value
				nEt	Display Net value
				PEAK	Display Peak value
				VALY	Display Valley value
				SNAP	Display Snap (Held) value
				PV-r	Peak & Valley Reset
				SCon	Shunt-Cal On
				SCoF	Shunt-Cal Off
				SCtG	Shunt-Cal Toggle on/off
dSnP	Do Snap (Hold current value)				

Auto Calibration

Using the Keypad; a simple two point calibration can be performed. Auto-calibration captures live load cell input values in mV/V terms and relates them to required engineering unit's values. The input can be acquired by loading the load cells with known weights or by injecting known mV levels for the required engineering values. These known mV/V levels may be taken from a load cell calibration sheet or by measurement.

The two calibration points should be near the required lowest point (typically an unloaded structure reading zero weight) and at least 75% of the highest point. This will help provide an accurate extrapolation over the desired calibrated range.

The sequence of calibration is not confined to capturing the Low calibration point **CALL** first. This is useful if a vessel already has a *known* amount of product in and it is not practical to empty the vessel before starting the calibration procedure.

For example: the calibration procedure can be initiated by capturing **CALH** with a full hopper if the weight is *known* and **CALL** captured at a later date when the hopper is empty.

Please note that the LCA20 may not display the correct weight until the second data point is acquired.



The Sensitivity **SEnS** and Decimal Point position **dP** must be set before calibration takes place.

Procedure



Allow a warm up period of 20 minutes before carrying out the calibration procedure.













If It is intended that the calibration is permanent then please ensure the EEPROM has not been disabled by the communications port. See [Communications Protocols](#) chapter.



The accuracy of the calibration depends upon the input being settled and stable.

This procedure is written assuming the low calibration point **CALL** is followed by the high calibration point **CALH** but note that **CALH** could be done first.

1. With the load cells connected and the load cells settled at the low calibration point (this could be the empty vessel) Press the  key until **PASS** appears.
2. LCA15: Enter the password 1111 using  and  keys, then press  key.
LCA20: Enter Level 2 password using  and  keys, then press  key.
3. LCA15: Press the  key several times until **CALL** appears.
LCA20: Press the  key several times until **ACAL** appears. Press the  key to select and **CALL** appears.



If **CALL** does not appear your LCA20 may be locked from calibration by your supplier!

4. Press the  key and check that the program symbol '' flashes.



Always ensure that the programmer indicator is flashing, even though the displayed value may not need to change.

5. If the required value for **CALL** is already displayed then move onto to the next step else enter the desired value that the input on the current load cells represents.
6. Ensure that the Strain Gauge has remained settled and is free from disturbance and press the **[G]** key to capture and calibrate the **CALL** value.
7. If the **CALH** calibration point is to be done at a later date then the **[R]** can be pressed and the values for **CALL** will be committed to memory. Else proceed to calibration high point **CALH** by pressing the **[G]**.
8. Apply the input to the load cells that represents the calibration high point **CALH** and allow to settle.
9. Press the **[▶]** key and check that the program symbol '←' flashes.



Always ensure that the programmer indicator is flashing, even though the displayed value may not need to change.

10. If the required value for **CALH** is already displayed then move onto to the next step else enter the desired value that the input on the current load cells represents.
11. Ensure that the Strain Gauge has remained settled and is free from disturbance and press the **[R]** key to capture and calibrate the **CALH** value and also commit these the values to memory.
12. On the display returning to indicating the load cell value and assuming the load has not changed on the load cells the display will now be showing the required values.

Notes on Auto calibration

- If **CALH** is set to zero then the display value will be mV/V with decimal point position being that set by **dP**.
- **CALL** can be greater than **CALH**. This will have the effect of for an increasing load cell input a decreasing displayed value.
- The calibration can be manually adjusted by changing the mV/V values stored in **AdCL** and **AdCH**. Care must be taken with changing these values and the resolution of entry is limited to 0.001mV/V.

MVV Source Calibration

If the load cell manufacturer's calibration certificate is available, a quality mV source, connected as shown below can be used to calibrate the LCA20 instead of applying the known High and Low calibration weights in the above procedure. This can be useful if it is not practical to load or unload the system for calibration.

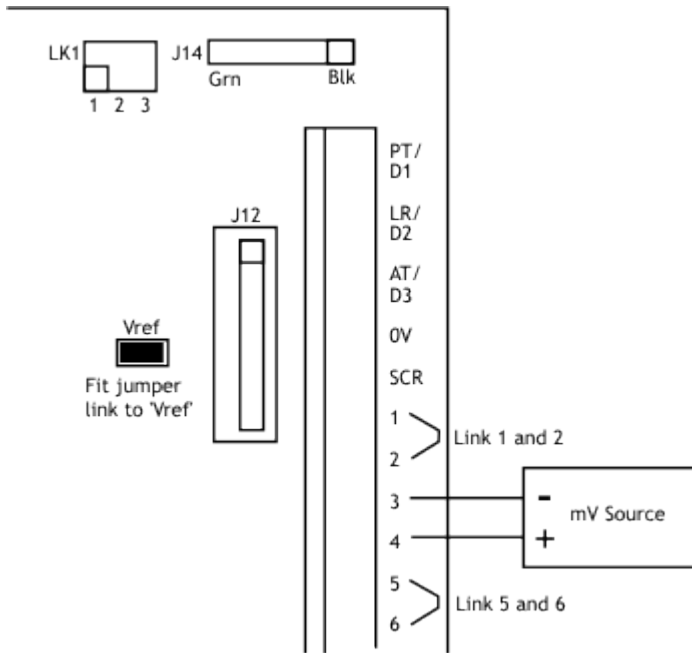

Fit the jumper link to the pins marked 'Vref'. See diagram above.

Measure and record the excitation voltage across 1 and 6 on the connector.

Multiply excitation voltage recorded by the mV/V values on the calibration certificate at the required calibration load. Two mV values are required, one for **CALL** and for **CALH**.

Now perform the above Auto-Calibration procedure setting the mV source to these values at steps 1 and 8.

Remember to remove the Vref jumper link before connecting the Load Cells.

Using the LCA Toolkit Software

The LCA Toolkit software for Windows will allow a connection with the LCA20 via an optional on-board communications module LC4 or via an optional programming cable PGM1.

What Can It Do?

The toolkit allows all aspects of the LCA20 to be configured. Everything that can be achieved with the plug-in programmer/display can be achieved with the toolkit plus a great deal more.

You can:

- Configure settings
- Save and restore settings to a file
- Calibrate load cell
- Calibrate analogue outputs
- Log data to a CSV file
- View data on a chart
- Use as a large display

Using the Software



These items just display data and you cannot interact with them.



These items are editable in place. Click on them to be able to change the contents.



These items are dropdown lists. Click on them to drop down a selection of items that can be clicked to select as shown below:

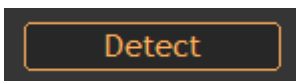
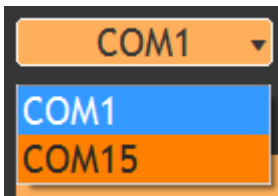

These are buttons. They will change colour dramatically when your mouse passes over them and look like this:

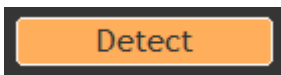

Click to activate.

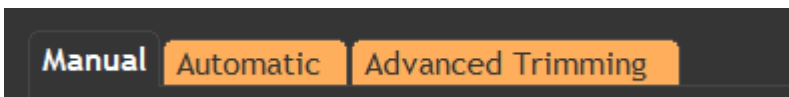

These items are tabs. The selected tab is not orange but you can click on the other tabs to select them. Different tabs will show different control items when clicked.

This is the first page shown after the software launches.

 Some of the pages shown here may not be available if your module has been locked by the supplier.

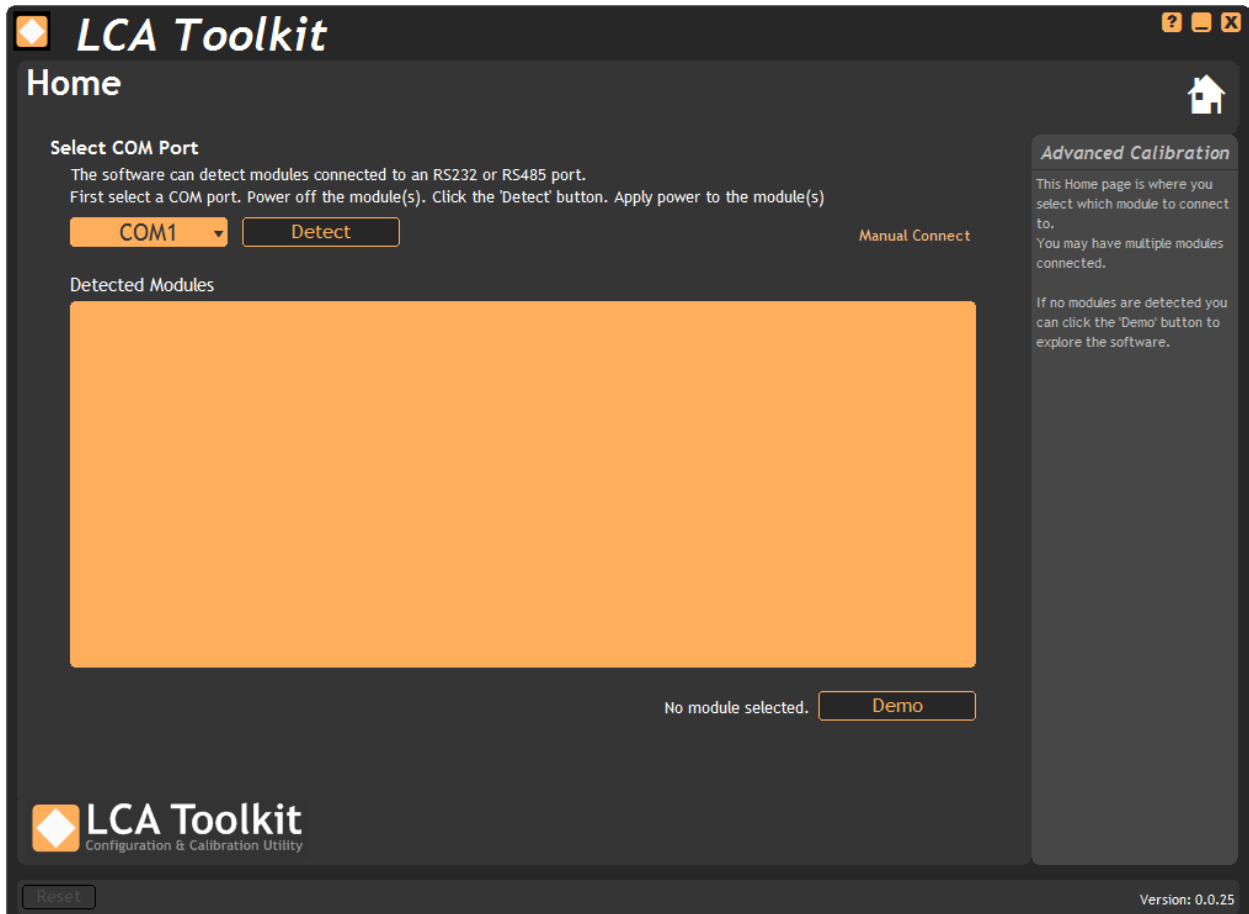

The serial ports (COM ports) on the computer are detected and added to the drop down list on the top left of the page. If you are using USB to RS232 or RS485 convertors then you can plug them in at this point. Clicking the drop down list will automatically re-detect available COM ports.

To detect the connected modules:

- Power off the LCA20 modules.
- Select the COM port that you module is connected to and click the **Detect** button.
- Apply power to the LCA20 modules. (Or if you have access to the push button on the module board you can press this (Hold for 1 second). This saves time if you only have one module connected as the software does not then have to wait to detect all other possible modules. See [Installation | Push Switch SW](#) for more information.)

The Toolkit will automatically detect all LCA20 modules connected to the selected COM port regardless of their baud rate, station number or protocol.

 If you cannot get physical access to the LCA20, to power cycle or to push the button, you can connect manually by clicking the 'Manual Connect' text on this page. See [Appendix G - Manual Connect](#).



If an RS485 bus is used the Toolkit can be operated when any number of LCA20 modules are connected to the bus but they **must** have already been allocated unique **Station Numbers**. If you have a group of modules straight from the factory they will all be allocated station number 1 by default so must be attached to the bus one at a time, connected to the Toolkit and their station number changed.

If one or more modules are detected they will be displayed in the main list. To connect to a module highlight it in the list and click the **Connect** button (or just double-click on the required module in the list).

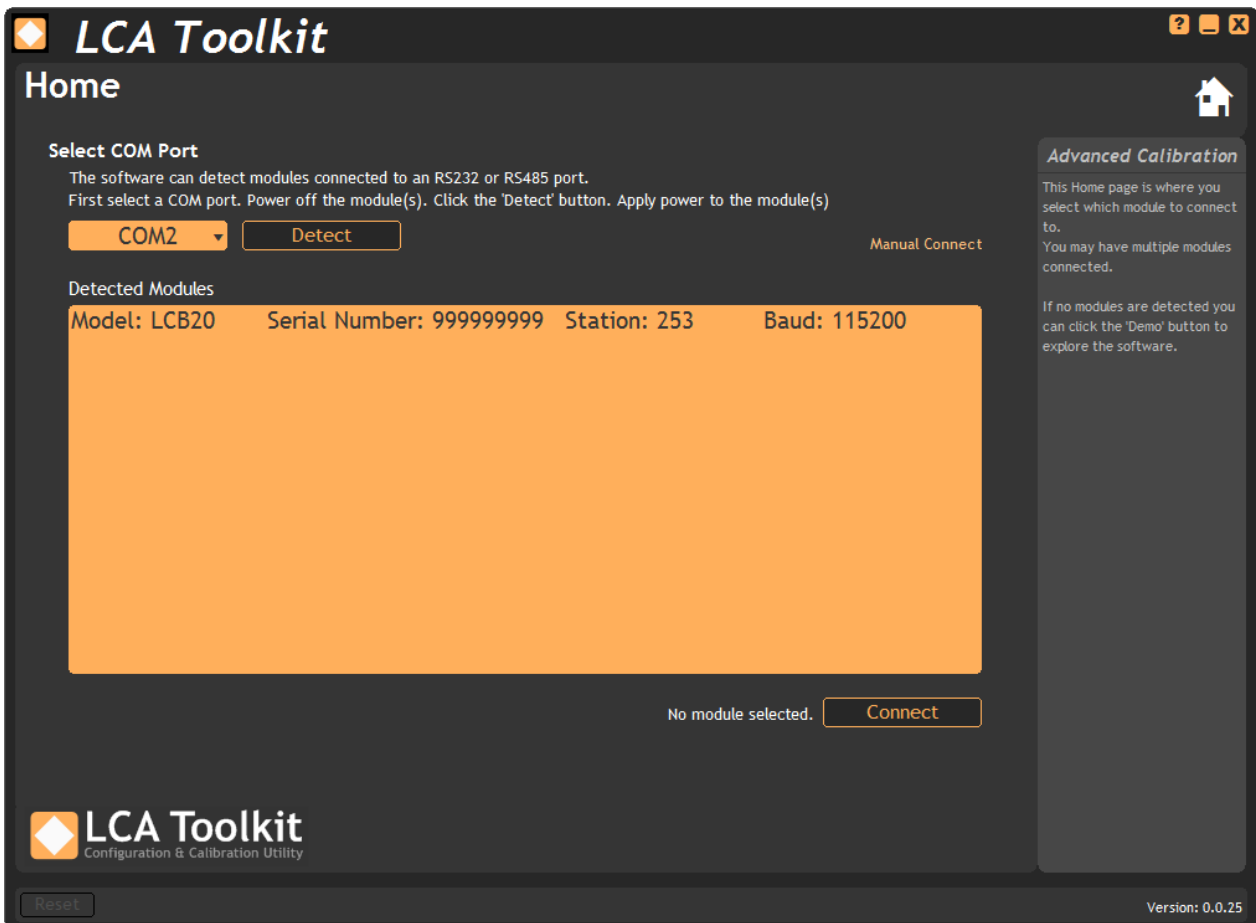

If more than one module is detected the software will also check that all the modules are set to the correct baud rate. If they are not you will be notified. If all connected modules are not set to the same baud rate you will need to connect them to the RS485 bus one at a time to set the desired baud rates.

Information ⓘ

The Information page shows useful information about the module. The large display may prove useful in simple monitoring projects.

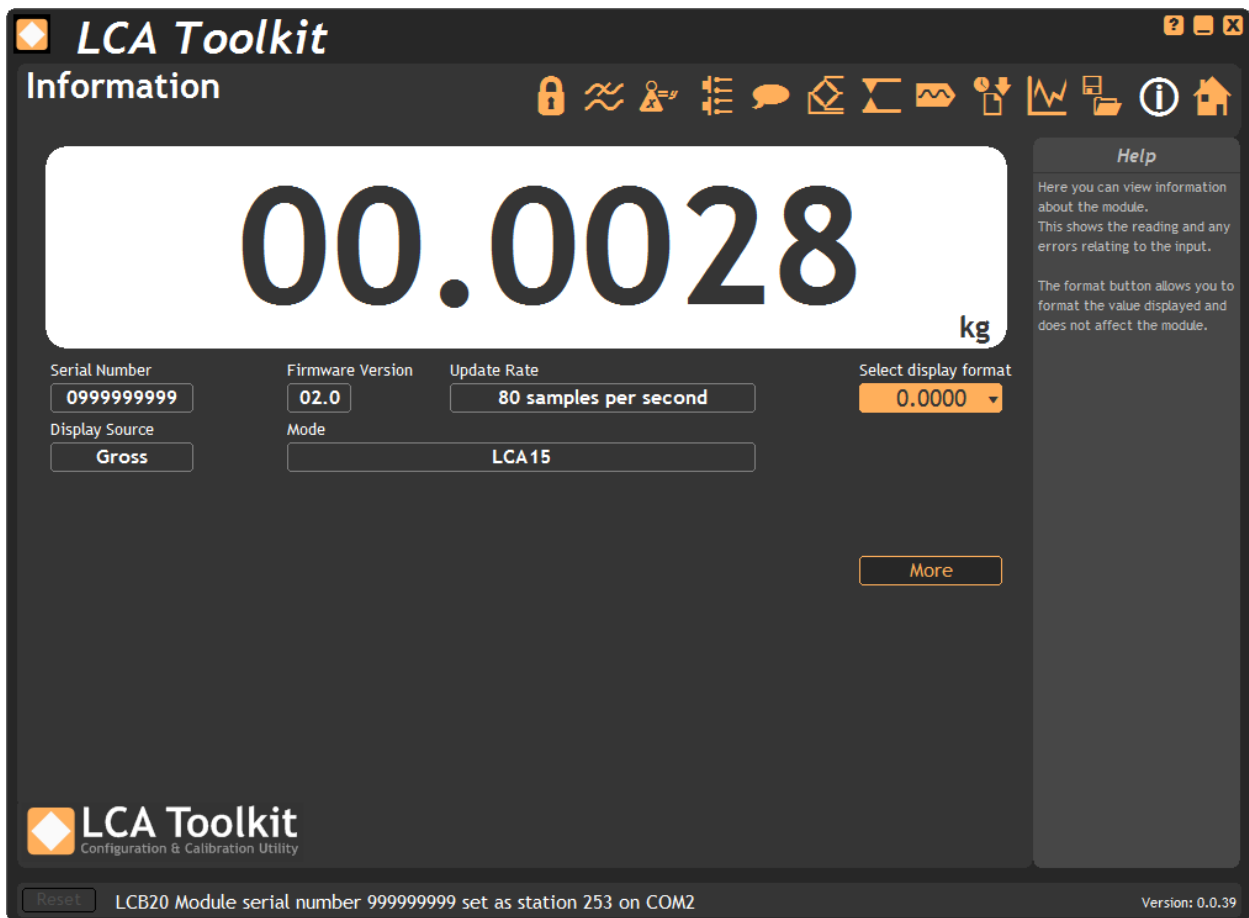

Main Display - Displays the module value. If units have been specified at calibration then the units will be shown.

Serial Number - Shows the serial number of the module.

Firmware Version - Shows the module firmware version.

Display Source - Indicates where the display (Parameter and LCD where fitted) gets its value.

Mode - Indicates the operational mode of the module. LCA15 is backwards compatible with the LCA15 module and LCA20 supports the new features.

Update Rate - Indicates the update rate of the module. This is the rate at which a new value is generated.

Select Display Format - Drop down the list and select a display format for this software only. This does not change any module settings.

More - Clicking this button displays more information as shown in the following screenshot.



Mode can be changed in the **Calibration** page. **Update Rate** is configured on the **Filters** page.

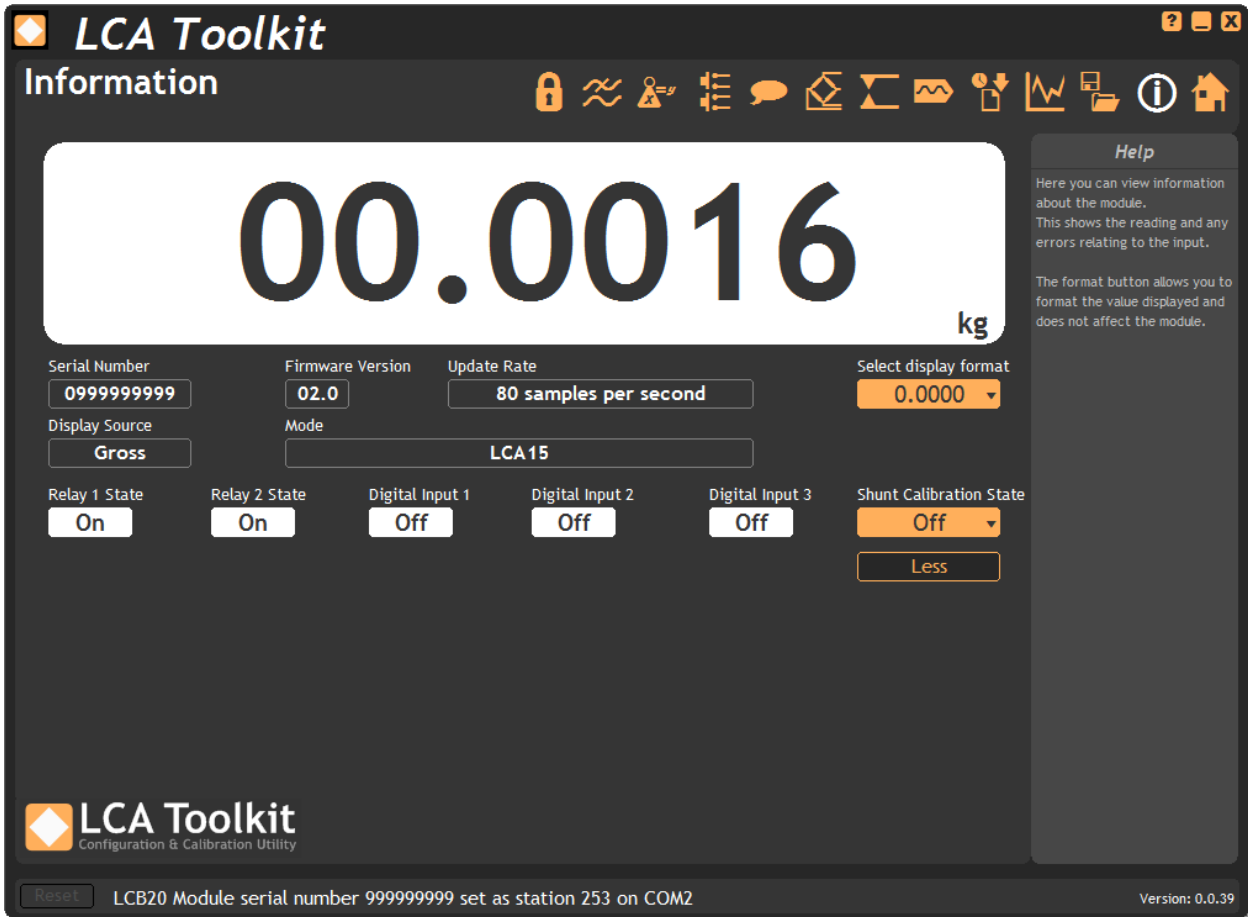

Relay 1 State - Indicates whether relay 1 is on or off.

Relay 2 State - Indicates whether relay 2 is on or off.

Digital Input 1 - Indicates whether digital input 1 is activated or not.

Digital Input 2 - Indicates whether digital input 2 is activated or not.

Digital Input 3 - Indicates whether digital input 3 is activated or not.

Shunt Calibration State - Allow the shunt calibration function to be activated.

Less - Clicking this button hides this extra information again.



See Also - [Appendix A - Calibration | Shunt Calibration](#)

Save & Restore

This page allows the configuration of the module to be saved to a file for later restoration.



Save - Save the module configuration to a file on the computer.

Restore - Restore a previously saved configuration file to the connected module.

Firmware Update - If you have a firmware hex file you can click this to select the file and update the firmware in the module.



Do not use LC4 communications port to update firmware. PGM1 Programming cable must be used when updating firmware.



Warning - A failed attempt at a firmware update will render the module inoperable until a valid firmware update has been achieved.

Trend Chart

This page allows you to view the module value on a scrolling chart. The chart will hold 10,000 points of data and is updated at the update rate of the module (Displayed at the top right of the chart). This is determined by the settings on the Filters page.

The chart Y axis is auto scaling but you can select the view into a stored history of 10,000 data points. Just drag the handles of the range scrollbar under the chart to define the start and end point of the view.

The date and time of the first and last point on the chart are displayed in the lower left and right area under the chart. By clicking in the chart you can display a cursor and the date and time at the point of the cursor, also the data point value will be displayed underneath the chart.

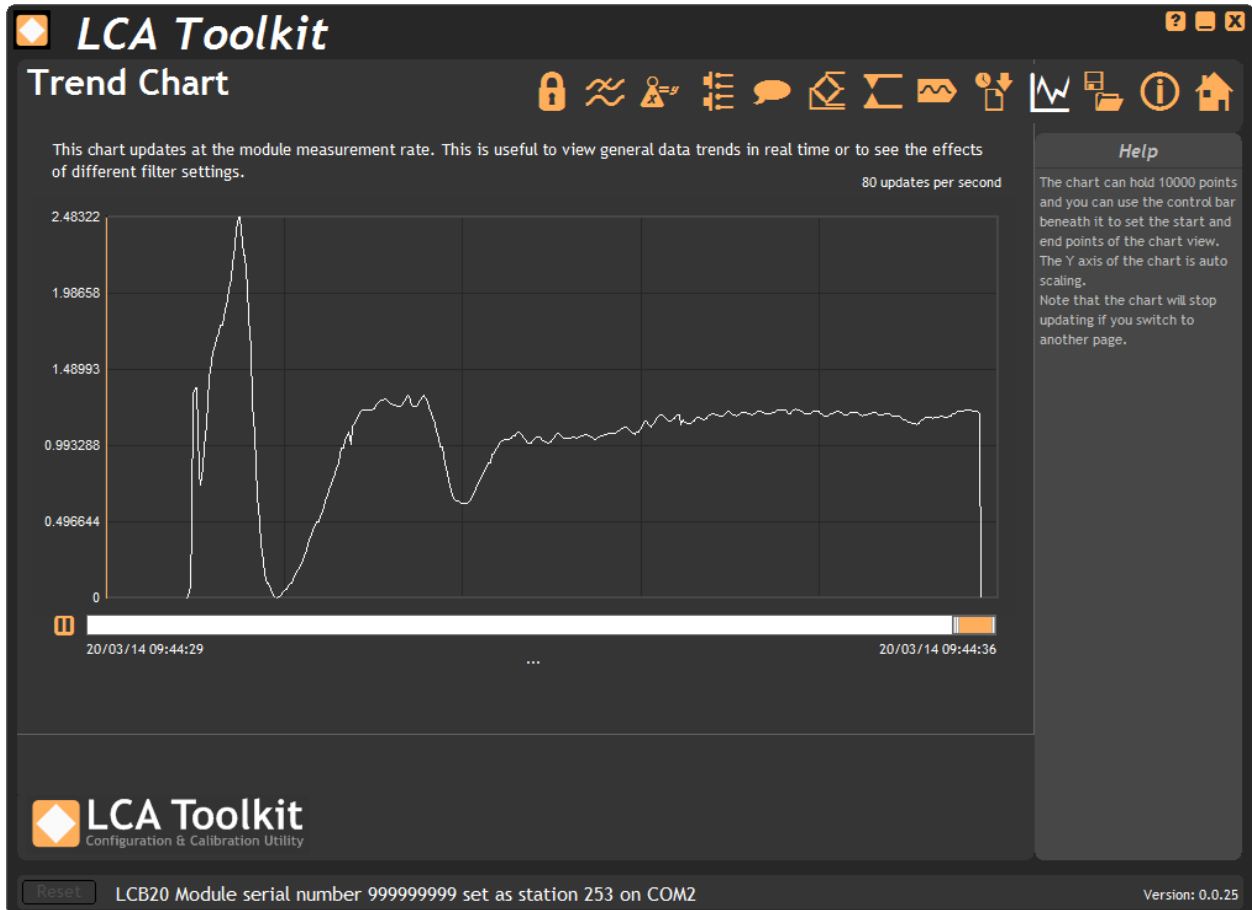

Pause Button - Pauses the chart. During a pause no more data will be added to the chart. You can use the range scrollbar to change the view or click and drag on the chart to move the cursor. The time and value of the data under the cursor will be displayed under the chart.

Range Scrollbar - By dragging the orange 'thumb' you can view different areas of the data history. By dragging the left or right side of the 'thumb' you can increase or decrease the amount of data shown thus zoom in and out.

Right Click Menu - Right clicking the chart will display a pop-up menu with three options:

Copy Chart Image - Copy a bitmap image of the chart to the clipboard.

Copy Chart Data - Copy tab separated chart data to the clipboard in a suitable format for pasting into MS Excel.

Clear Chart - Clear all data from the chart.

Logging

The toolkit allows you to log data to a CSV (Comma Separated Value) file. This file can be opened for analysis in various applications including MS Excel.

The logging session can be manually controlled or automatically stopped after a duration/number of logs limit.

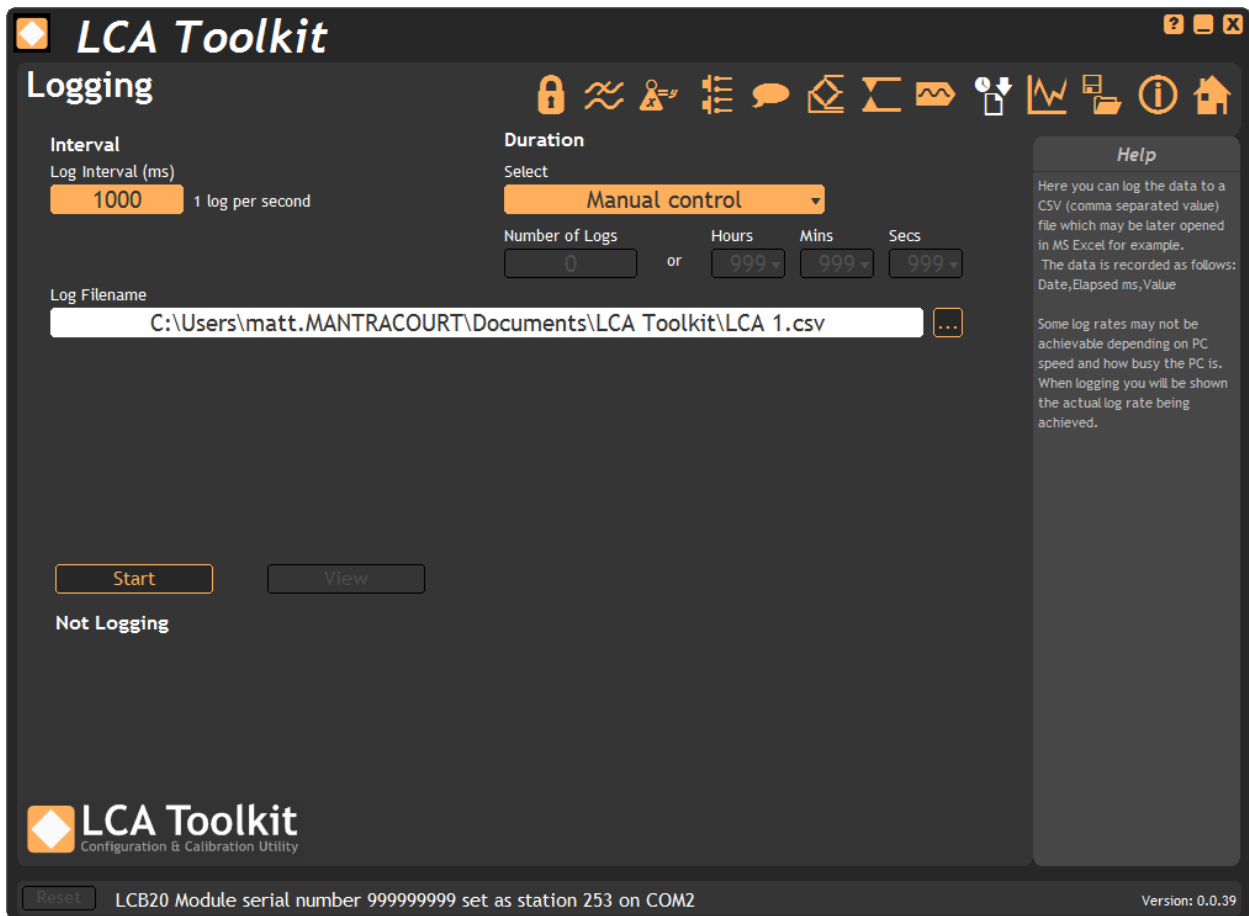

Interval

Log Interval - Choose a Log Interval in milliseconds between 12 and 32000. For example 20mS will enable a log at 50Hz.

Duration

Select - Choose whether you want **Manual control**, so you can click the **Start/Stop** button whenever you want, or choose **Based on number of logs** or **Based on timed duration**.

If you choose either of the last two options you can define the length of the log by entering either a number of logs to record or the time to record in hours, minutes and seconds.

Number of Logs - if you choose **Based on number of logs** then you can enter the number of logs here. The hours, minutes and seconds will update to show the actual duration based on the number of logs and the log interval.

Hours:Minutes:Seconds - if you choose **Based on timed duration** then you can choose the hours, minutes and seconds here. The number of logs will update based on the duration and the log interval.

Log Filename - Select a file to log to.



Each time the log starts it will erase any data already in the file.

Start - Clicking this button will start the log.

Stop - Clicking this button will stop the log.

View - When a log has just been stopped this button will launch the application associated with CSV files.

The format of the log file is as follows:

DateTime, Elapsed, Value

Where:

DateTime is the date and time in long format

Elapsed is the time elapsed in milliseconds since the start of the log

Value is the numeric value logged

Example:

```
08/06/2009 15:41:08,0,-3.253001E-03
08/06/2009 15:41:08,10,-3.253001E-03
08/06/2009 15:41:08,43,-3.253001E-03
08/06/2009 15:41:08,60,-3.253001E-03
```

If the measurement rate of the module is less than the rate at which you have chosen to log you will be informed with a message as shown below.

Either reduce the **Log Interval** or reduce the **Measurement Rate**.



If you are using a serial / USB convertor there may be some driver settings that can affect the speed of logging. See [Programming Cable PGM1 | Driver Settings](#) chapter for information that may be relevant.

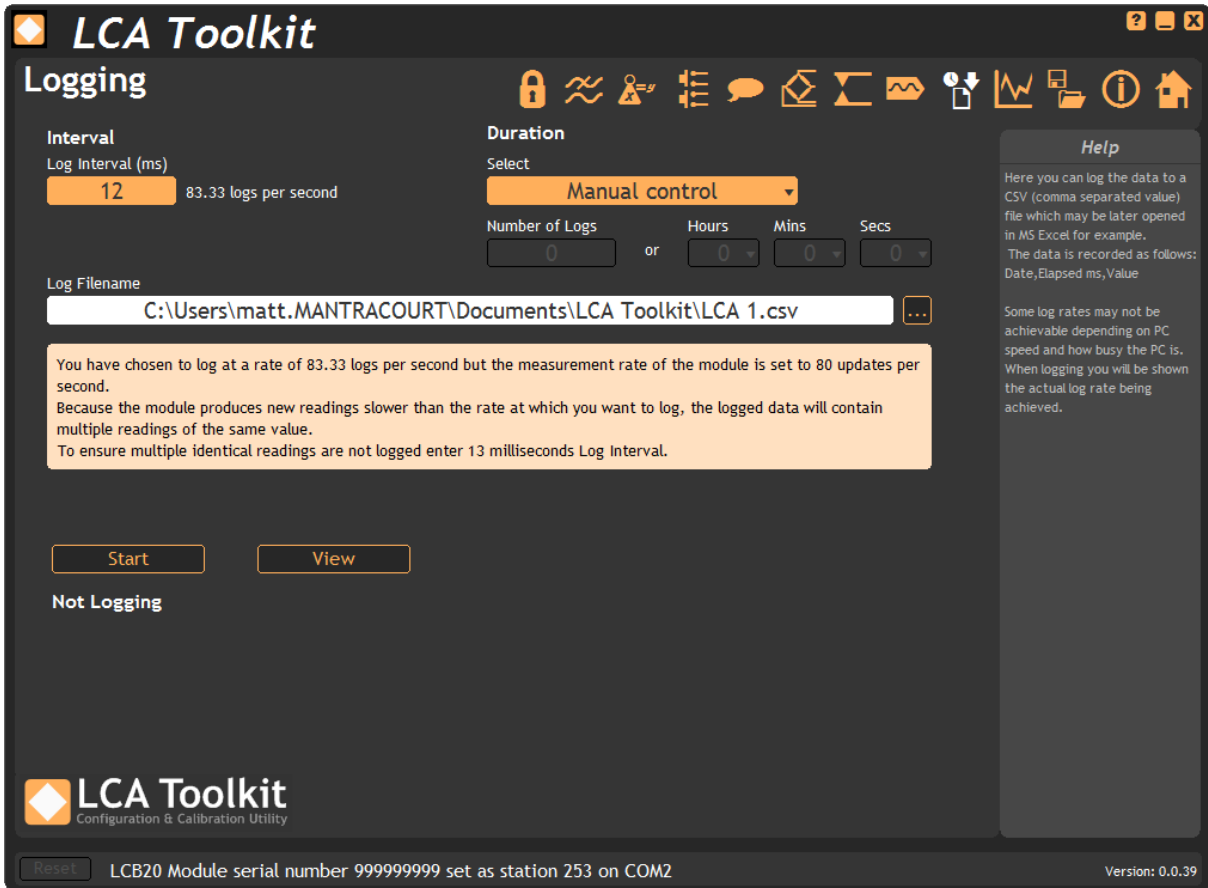

Once the logging starts the actual achieved log rate will be displayed at the bottom of the window. This is useful for diagnostics such as when a heavily burdened PC is slowing the log rate.

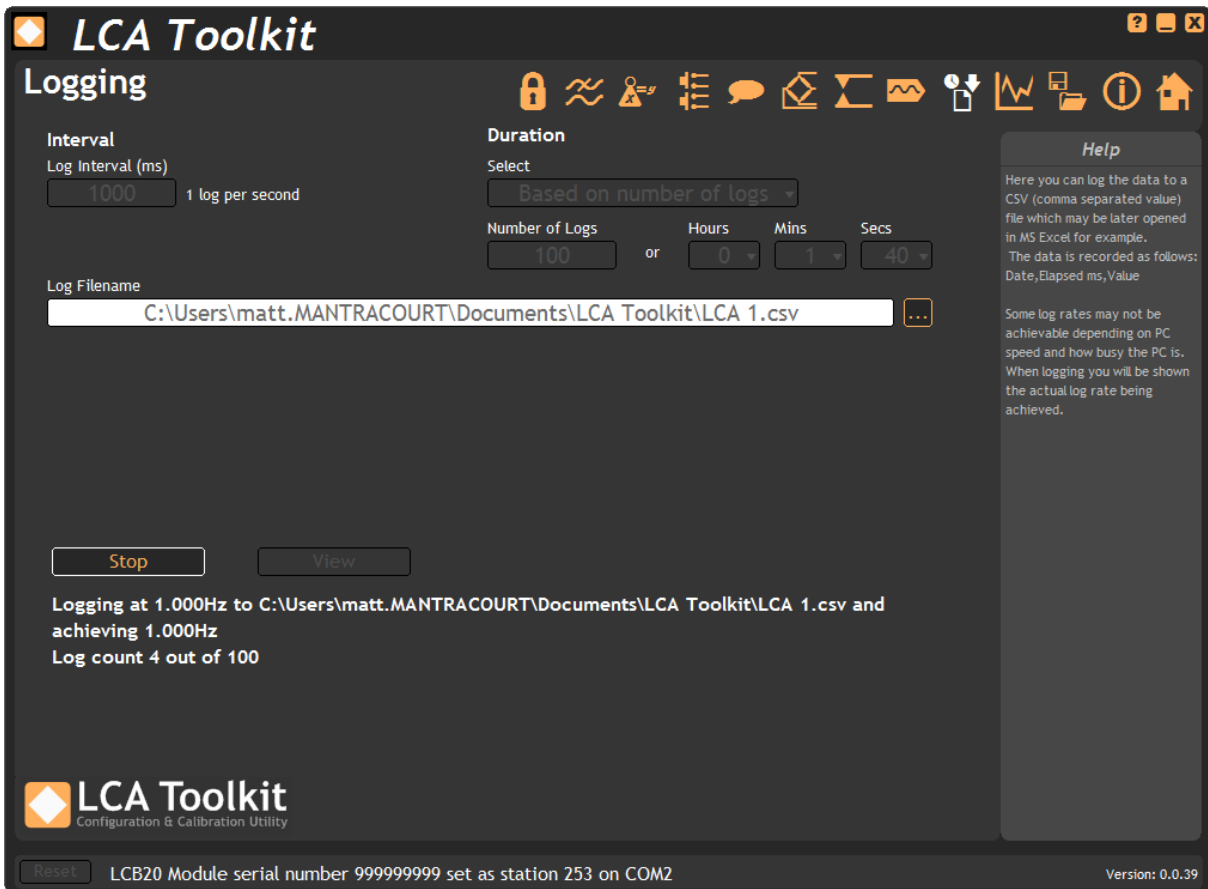

Analogue Outputs

This page allows the configuration and calibration of the analogue outputs.

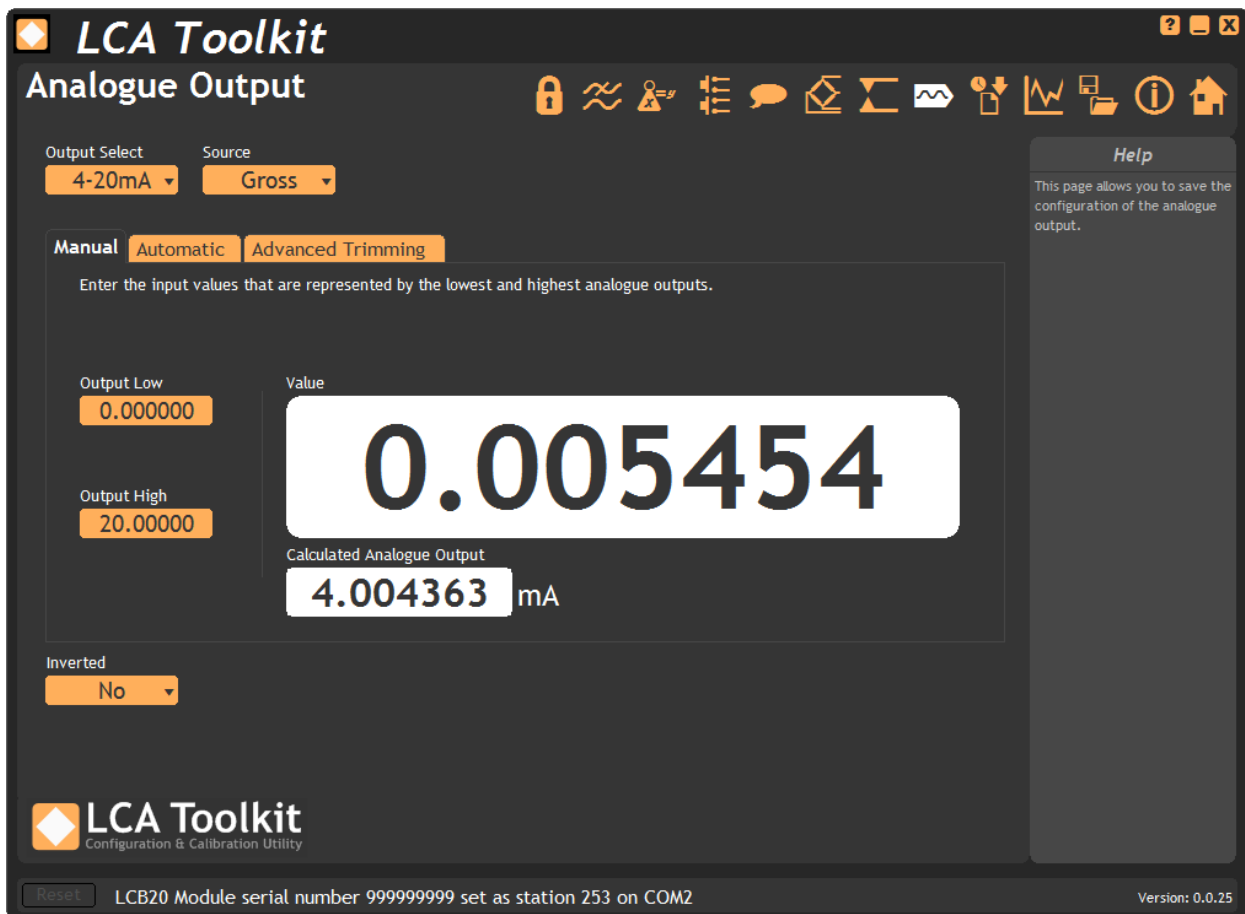

Output Select - Choose between 4-20mA current output or 0-10V voltage output.

Source - Select the source value that the analogue output is based on.

Inverted - Select this to invert the output. The original LCA15 did not allow Output Low to be higher than Output High so this option had the same effect as entering a higher value for Output Low than for Output High. This new module will allow you to do this in both modes so this option is for backwards compatibility.

Manual Tab - This tab allows you to manually specify the values that relate to the minimum and maximum analogue output levels.

Output Low - Enter the value (of the source selected above) at which the analogue output will be at the minimum level (4mA or 0V).

Output High - Enter the value (of the source selected above) at which the analogue output will be at the maximum level (20mA or 10V).

Value - This shows the current selected source value.

Calculated Analogue Output - Shows the calculated analogue output for the current input value. Note that this calculated value may be beyond what the output is capable of providing.

Automatic Tab - If you do not know what input value relate exactly to the minimum and maximum analogue output levels but you do know the input values for other output values use this tab.

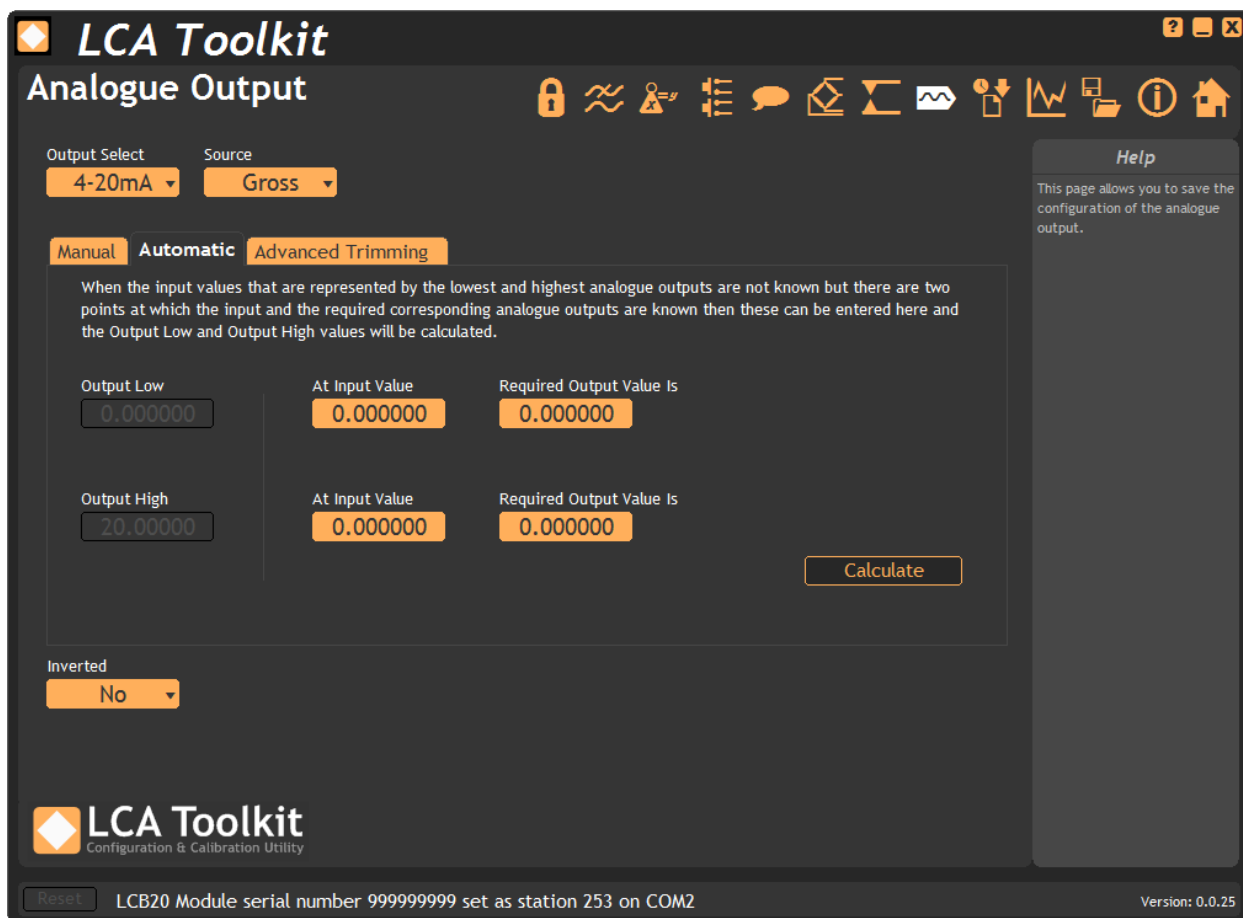

- Output Low** - Shows the new **Output Low** value after you click the **Calculate** button.
- Output High** - Shows the new **Output High** value after you click the **Calculate** button.
- At Input Value** - Enter an input value that you know the required analogue output value for. There are one of these for the low level and one for the high level.
- Required Output Value Is** - Enter the required analogue output value for the input value you have specified. There are one of these for the low level and one for the high level.
- Calculate** - Click this button to calculate new **Output Low** and **Output High** values based on the information you have entered.

Advanced Trimming Tab - Sometimes when the analogue outputs are correct the device you are feeding the analogue output into does not (because of inaccuracies in that device) read the correct value. The gain and offset virtual knobs allow you to tweak the gain and offset of the analogue output to achieve fine control rather than perform measurements and recalculate Output Low and Output High Values. Also tweaking the gain and offset is the only way to push the analogue output past the min and max values (0V, 4mA and 10V, 20mA).

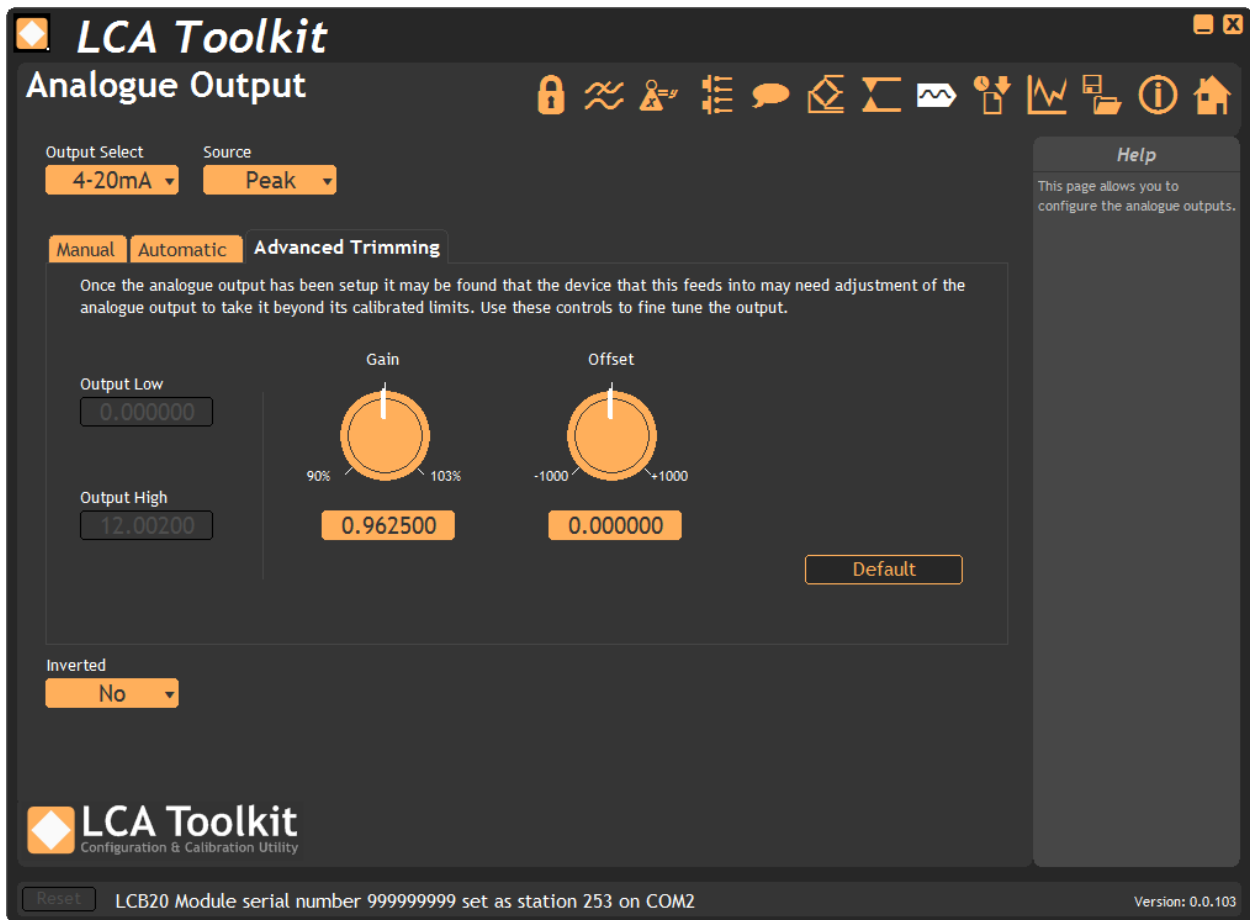

Gain - Alter the analogue output gain by clicking and dragging the pointer on the virtual knob.

Offset - Alter the analogue output offset by clicking and dragging the pointer on the virtual knob.

Default - Clicking this button will return the gain and offset to default values.

i The gain and offset are interactive. You may need to alternate between the adjustments to achieve the desired effect. These virtual knobs replace the physical trimmers on the original LCA15 module.

Relays

This page allows you to configure the relays.

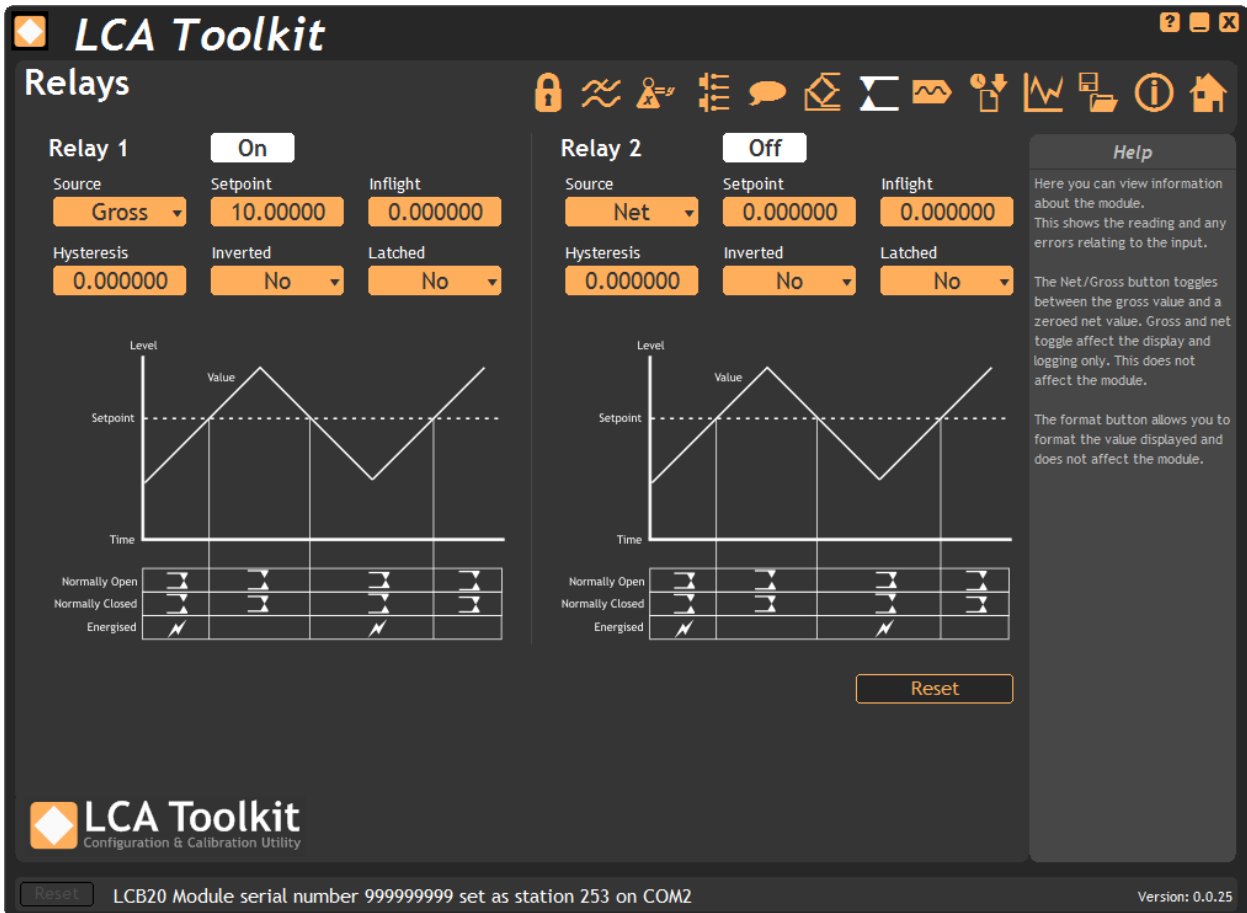

Source - Select the source of the value that the relays will act upon.

Setpoint - The target value at which the relay operation will function. The actual point at which contacts may changeover may be affected by Inflight and hysteresis value.

Inflight - Compensates for amount of delivered product still falling even after valves are closed.

Hysteresis - This is used to stop relay chatter and affects the actual point that relay contact changeover occurs.

Inverted - Whether the operation of the relay is inverted.

Latched - Once contacts have changed this option can be used to latch the relays. A serial command or digital input is then required to reset the relay contacts. Relays only latch in deactivated state.

Reset - Click this button to reset any latched relays.



See Also - [Appendix C - Relays](#) for more information.



In LCA20 mode each relay has an independent Hysteresis value but in LCA15 mode both relays operate from a single Hysteresis value.

Measurement

This page shows how the core measurement values relate to each other.

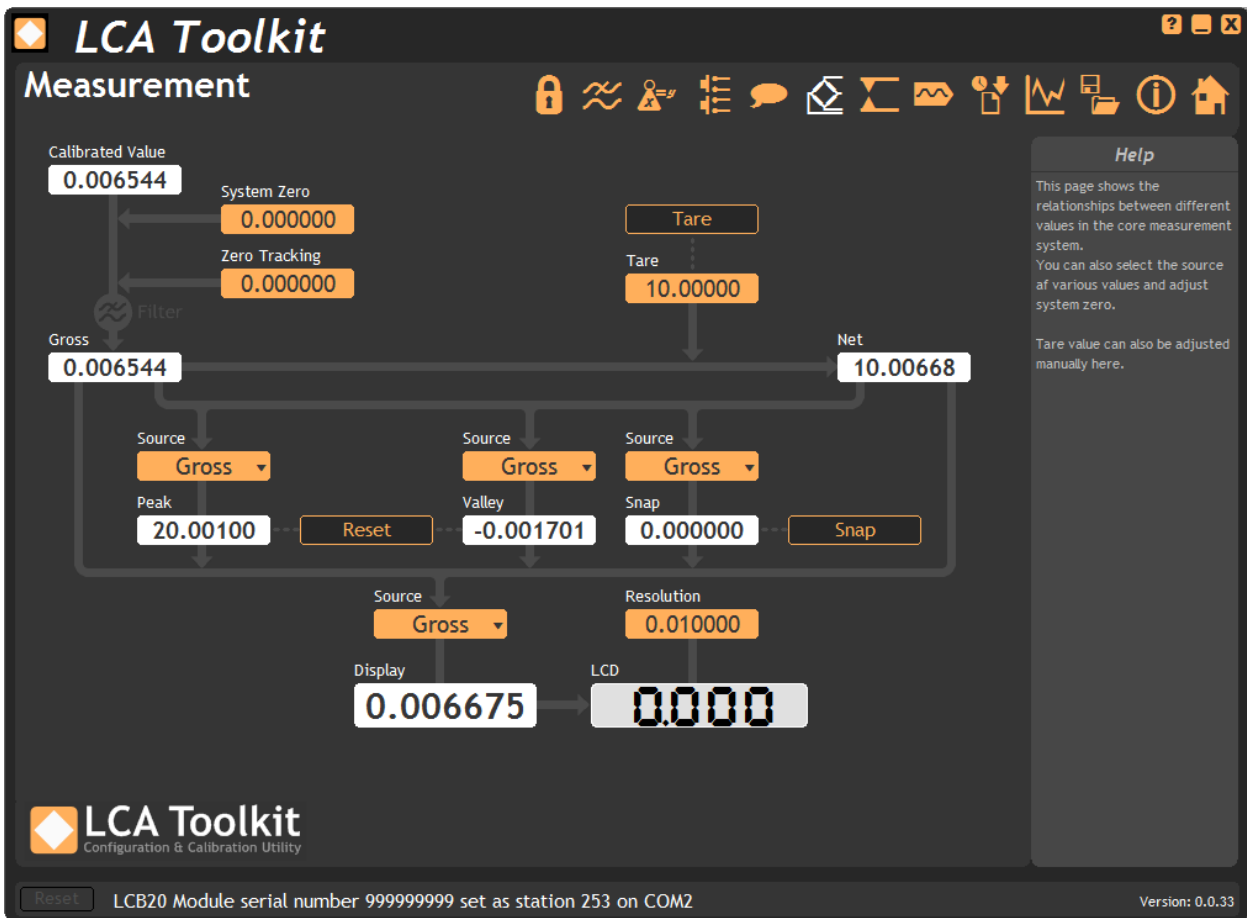

Calibrated Value - Shows the calibrated value. Calibration turns the input mV/V value into this value.

System Zero - Enter a value here that is added to the **Calibrated Value** to produce the **Gross** value. System Zero is used to remove permanent values from an installed system such as the weight of a vessel or weighing platform to give a zero Gross value.

Zero Tracking - Zero tracking is applied after the system zero and compensates for small changes in the input to allow for a zero Gross value. See [Appendix B - Zero Tracking](#) for more information.

Gross - The Gross value of the system.

Net - The Net value of the system is generated from the Gross value plus the Tare value.

Tare - The Tare value is added to the Gross value to generate the Net value.

Peak - Indicates the highest value measured since power up or last Peak/Valley Reset.

Peak Source - Select which source the peak value is based on.

Valley - Indicates the lowest value measured since power up or last Peak/Valley Reset.

Valley Source - Select which source the valley value is based on.

Reset Button - Reset the peak and valley values to the current source value.

Snap - Shows the last snap value recorded.

Snap Source - Select which source the snap value is based on.

Snap Button - Perform a snap recording now. (This control is included for demonstrating the function and has limited use for a single module. In actual use the snap command would be a broadcast communications command to enable multiple modules to record values at the same time. The snap value can then be retrieved from each module.

Display - Shows the main value that is indicated on the optional display. Note that the actual value shown on the LCD may differ from this floating point value due to the **Resolution** parameter setting.

Display Source - Select the source for the display value.

LCD - Mimics the actual display that would be shown on the optional LCD display.

Resolution - This parameter value sets the block size that the optional LCD display will increment and decrement by. This setting does not affect anything other than the LCD display.

Communications

This page configures the communications interface for communication via other software. The settings do not affect the ability of the Toolkit to connect to the module. However, at low baud rates it may not be possible to log data or update the chart page at the measurement rate of the module. A higher baud rate will result in a more responsive experience with this Toolkit.



Protocol - Select the required communications protocol. All modules on the same communications bus should be set to the same protocol.

Station Number - When using multiple modules on a suitable communications bus, such as RS485, each module must have a unique Station Number to allow communications to work. Here the module station number can be selected.

Baud Rate - Select the required baud rate for the module. All modules on the same communications bus should be set to the same baud rate.



The module will require power cycling to enable changes to any of the above settings. The Home button should be clicked before power cycling the module as the Toolkit will not be able to communicate if the module is power cycled while left on this page.

Digital Inputs

Allows the function of digital inputs to be set and indicates the current state of the inputs.

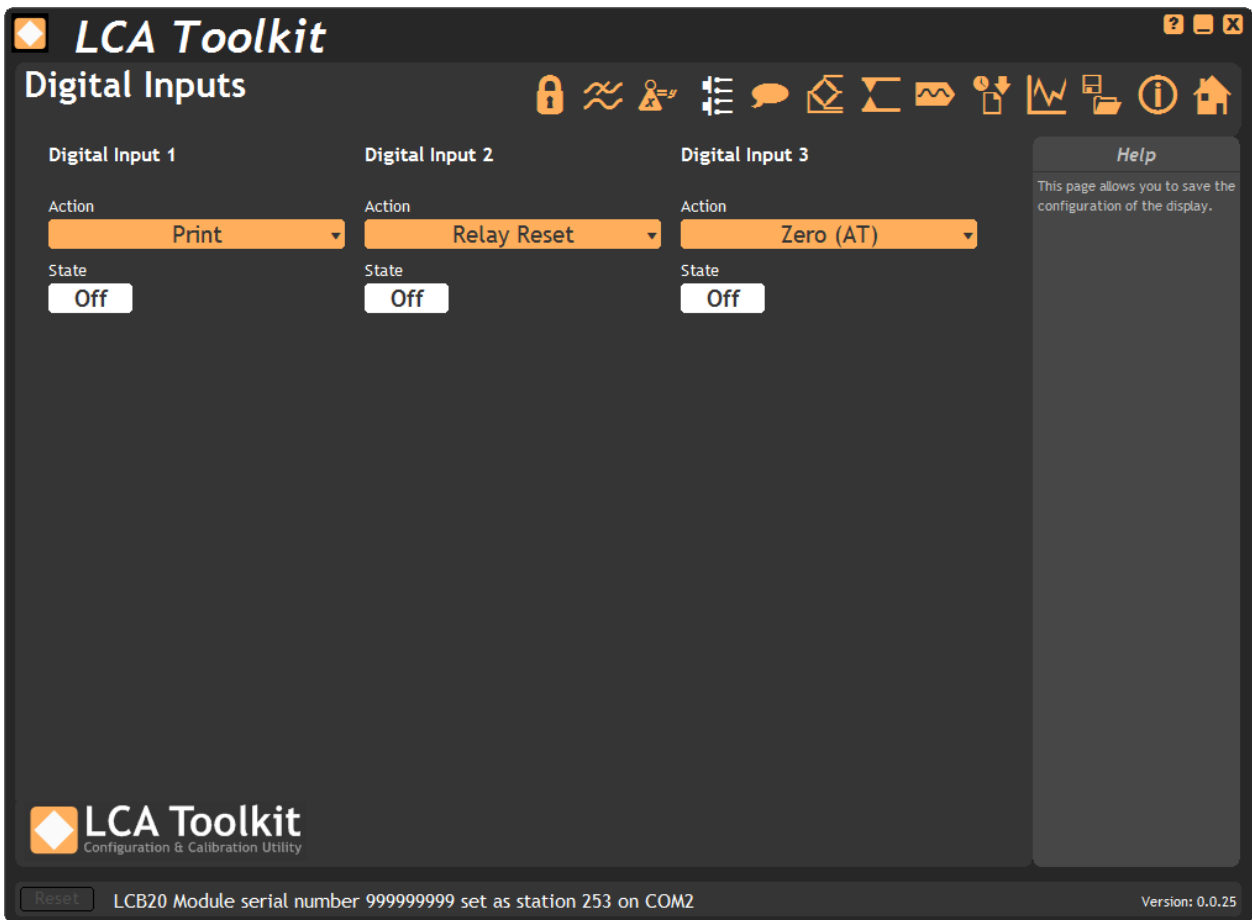

For each of the three digital inputs the following settings are available:

Action - Select the action to execute when the digital input is activated.

State - Indicates the current state of the digital input.



See Also - [Appendix E - Digital Inputs](#) for more information.

Calibration

The calibration page offers three ways to calibrate the module and also allows configuration of shunt calibration.

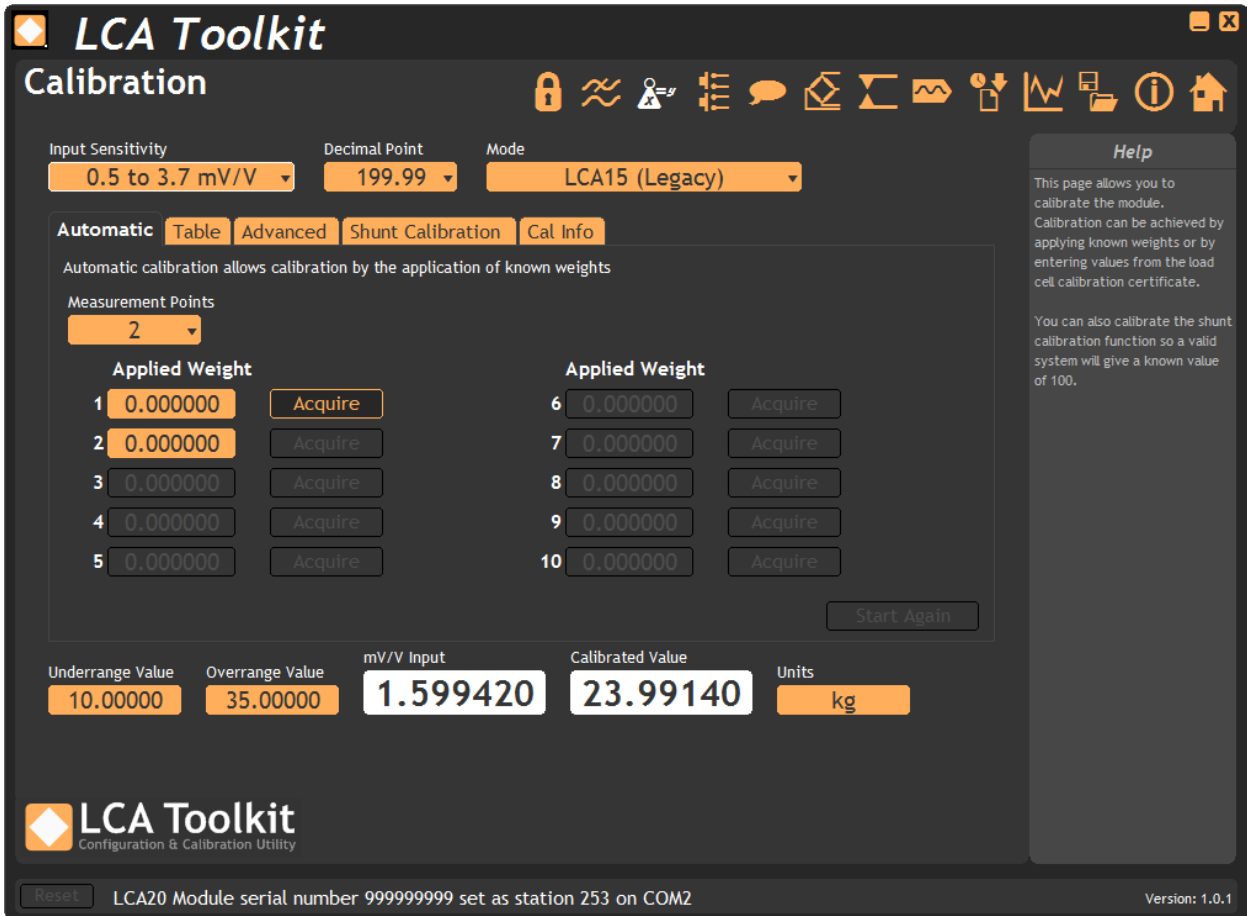

The Input Sensitivity and Decimal Point parameters should be decided on before calibration takes place. Changing either after calibration may void that calibration.

Input Sensitivity - Choose the appropriate range for the load cell sensitivity that is connected.

Decimal Point - This setting determines the maximum range of the engineering units for the module. *This must be selected to allow for the maximum value likely to be encountered.*

Mode - Choose whether the programmer menu structure will be the same as the previous version LCA15 or whether it will contain newer parameter access for the LCA20.

Underrange Value - Enter the engineering unit value of the **Gross** value below which the underrange flags will be set. The output value will change to -20001 with the decimal point as defined above. The optional LCD display will show -1 with no other digits shown.

Overrange Value - Enter the engineering unit value of the **Gross** value above which the overrange flags will be set. The output value will change to +20001 with the decimal point as defined above. The optional LCD display will show +1 with no other digits shown.

mV/V Input - The mV/V value measured at the input.

Calibrated Value - The mV/V value after having the calibration applied.

Units - Optional 6 characters of units that will be displayed on the main Information page.

The following sections will deal with each of the tabs available on the calibration page.

Automatic Tab

Select this tab to calibrate the module by applying known loads.

i Each time you enter this page it will hold the last data entered or will be blank ready to accept values. i.e. The page is used to generate the calibration data seen in the Advanced Tab but does not reflect any data held in the module.

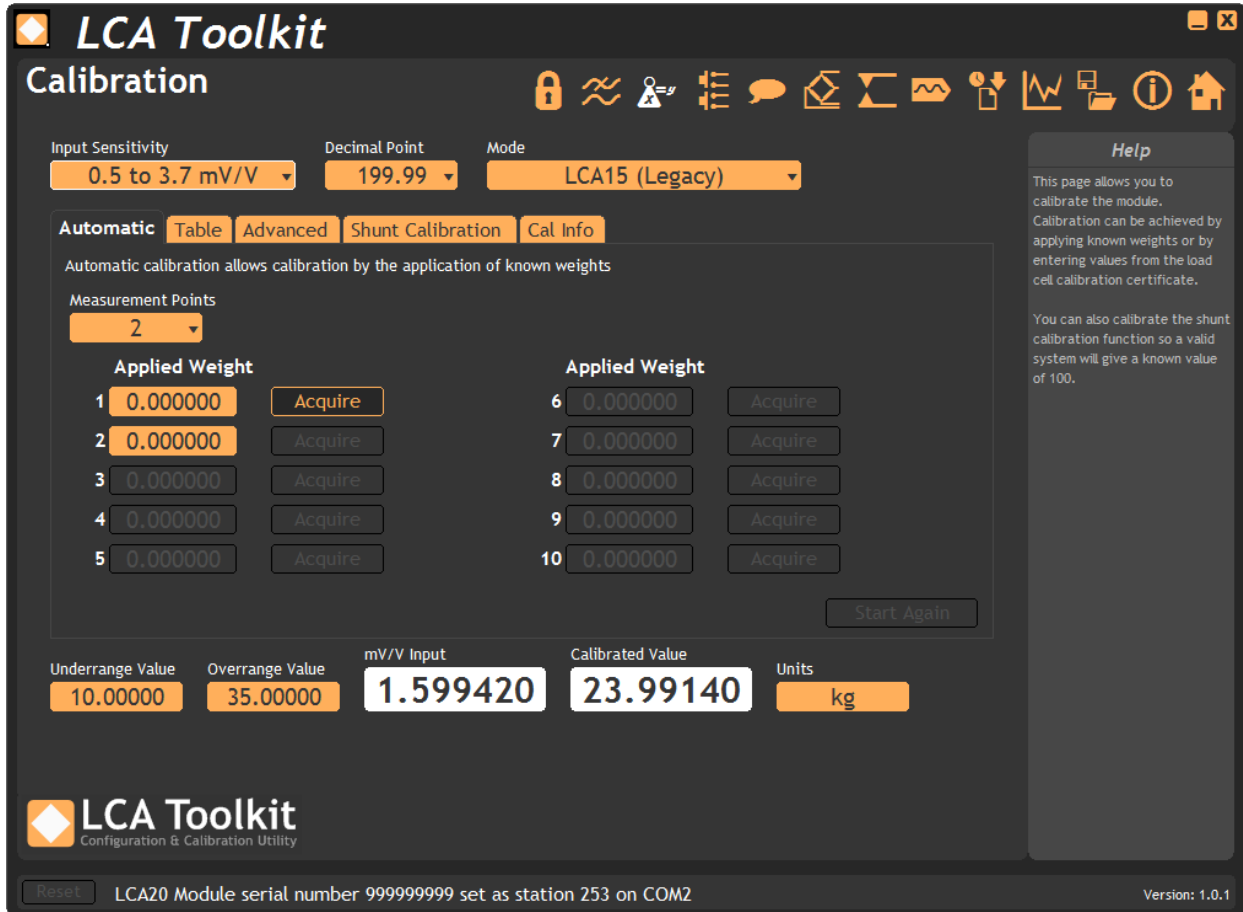

Measurement Points - Enter between 2 and 10 measurement points. These are the points at which weights will be applied. This process will linearise as it calibrates.

The following pair of controls will be available for the number of measurement points selected.

Applied Weight - Enter the known weight applied at this measurement point. The weights must be applied in ascending order.

Acquire Button - Once the input has been given enough time to settle click this button to acquire the point and start calculating calibration values. You can then redo the calibration at this point again or move on to the next calibration point.

Start Again - Click this button to restart the calibration process.

Table Tab

Select this tab if the mV/V input values are known for 2 or more known weights. This can be used to calibrate based on load cell manufacturer certificates and there is no need to apply actual weights.



Each time you enter this page it will hold the last data entered or will be blank ready to accept values. i.e. The page is used to generate the calibration data seen in the Advanced Tab but does not reflect any data held in the module.

LCA Toolkit
Calibration

Input Sensitivity: 0.5 to 3.6 mV/V | Decimal Point: 19.999 | Mode: LCA20

Automatic | **Table** | Advanced | Shunt Calibration | Cal Info

Table calibration allows calibration by specifying mV/V output values for known weights applied to the connected loadcell

Calibration Points: 2

	mV/V	Engineering Units	mV/V	Engineering Units
1	0.000000	0.000000	6	0.000000
2	0.000000	0.000000	7	0.000000
3	0.000000	0.000000	8	0.000000
4	0.000000	0.000000	9	0.000000
5	0.000000	0.000000	10	0.000000

Underrange Value: -19.99900 | Overrange Value: 19.99900 | mV/V Input: 0.650778 | Calibrated Value: 0.984214 | Units: kg

LCA Toolkit
Configuration & Calibration Utility

Reset | LCB20 Module serial number 999999999 set as station 253 on COM2 | Version: 0.0.25

Calibration Points - Enter the number of known mV/V and engineering unit value pairs.

The following pair of controls are repeated for each calibration point.

mV/V - Starting from the lowest mV/V value enter the known value for this point.

Engineering Units - Enter the known engineering unit weight for the stated mV/V value.

Calibrate - Click the Calibrate button to calculate the calibration settings based on the information entered.

Advanced Tab

This gives access to the internal gain and offset values. This is considered advanced and care should be taken in this tab.



The data shown on this page is the actual calibration data held in the module. Use with caution!

The screenshot shows the 'LCA Toolkit' Calibration interface in the 'Advanced' tab. At the top, there are settings for 'Input Sensitivity' (0.5 to 3.6 mV/V), 'Decimal Point' (19.999), and 'Mode' (LCA20). Below these are tabs for 'Automatic', 'Table', 'Advanced' (selected), 'Shunt Calibration', and 'Cal Info'. A warning message states: 'The table below contains the raw calibration data held in the module. Edit these values with caution'. A 'Calibration Points' dropdown is set to '2'. The main table displays calibration data for 10 points (1-10). Each point has three input fields: mV/V, Gain, and Offset. The 'mV/V' values for points 1-5 are 0.484108, 3.876542, 0.000000, 0.000000, and 0.000000 respectively. The 'Gain' values for points 1-5 are 5.895472, 5.895472, 0.010000, 0.010000, and 0.010000 respectively. The 'Offset' values for points 1-5 are 2.854045, 2.854045, 0.000000, 0.000000, and 0.000000 respectively. Points 6-10 have mV/V values of 0.000000, Gain values of 0.010000, and Offset values of 0.000000. A 'Defaults' button is located at the bottom right of the table. Below the table, there are fields for 'Underrange Value' (-19.99900), 'Overrange Value' (19.99900), 'mV/V Input' (0.650645), 'Calibrated Value' (0.982338), and 'Units' (kg). The LCA Toolkit logo and 'Configuration & Calibration Utility' text are at the bottom left. A 'Reset' button and the text 'LCB20 Module serial number 999999999 set as station 253 on COM2' are at the bottom center. The version 'Version: 0.0.25' is at the bottom right.

	mV/V	Gain	Offset	mV/V	Gain	Offset	
1	0.484108	5.895472	2.854045	6	0.000000	0.010000	0.000000
2	3.876542	5.895472	2.854045	7	0.000000	0.010000	0.000000
3	0.000000	0.010000	0.000000	8	0.000000	0.010000	0.000000
4	0.000000	0.010000	0.000000	9	0.000000	0.010000	0.000000
5	0.000000	0.010000	0.000000				

Calibration Points - Shows the number of calibration points in the calibration.

The following triplets of controls are repeated for each calibration point.

mV/V - Between this mV/V value and the next the following gain and offset will be used to convert the value to the Calibrated Value.

Gain - The gain (multiplication factor) applied to the mV/V value.

Offset - The offset added to the $mV/V * Gain$ value to give the Calibrated Value.

Defaults - Click this button to revert all calibration data to factory defaults. The Calibrated Value will then be mV/V.

Shunt Calibration Tab

This tab allows the calibrating of the shunt calibration function. After a load cell has been connected to the module and all wiring and connectors have been finalised the Shunt Calibration can be calibrated so that the Shunt Calibration output always indicates 100.00 if nothing has changed on the load cell or wiring. This value will indicate 100.0 regardless of the weight on the load cell at the time the shunt calibration is activated. This allows very quick checking of calibration and hardware integrity.

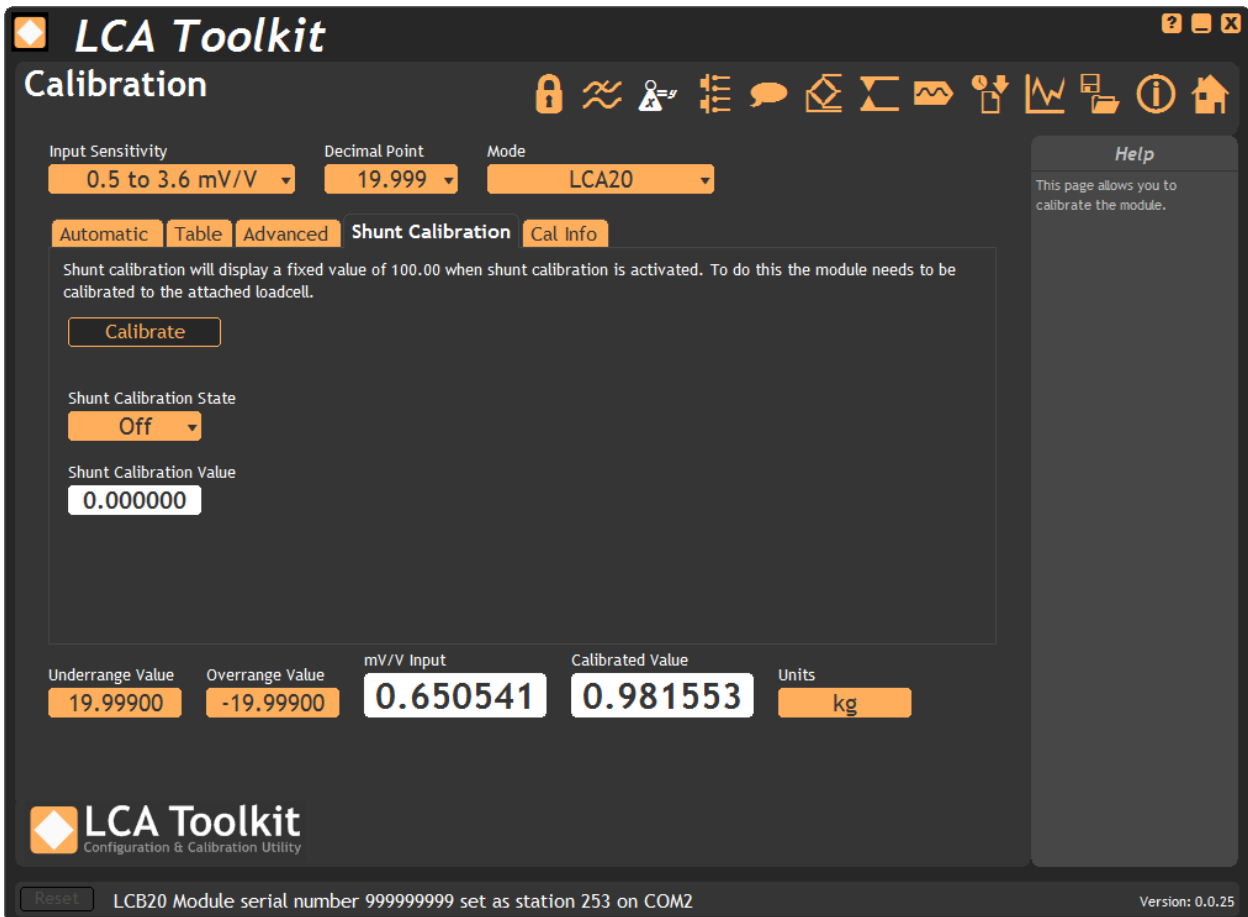

The screenshot displays the 'LCA Toolkit' interface for the 'Calibration' tab. At the top, there are settings for 'Input Sensitivity' (0.5 to 3.6 mV/V), 'Decimal Point' (19.999), and 'Mode' (LCA20). Below these are tabs for 'Automatic', 'Table', 'Advanced', 'Shunt Calibration', and 'Cal Info'. The 'Shunt Calibration' tab is active, showing a 'Calibrate' button and a 'Shunt Calibration State' dropdown set to 'Off'. The 'Shunt Calibration Value' is displayed as 0.000000. At the bottom, there are fields for 'Underrange Value' (19.99900), 'Overrange Value' (-19.99900), 'mV/V Input' (0.650541), 'Calibrated Value' (0.981553), and 'Units' (kg). A 'Reset' button and a status bar at the bottom indicate the module serial number and version (0.0.25).

Calibrate - Click this button to calibrate the shunt to the current load cell attached.

Shunt Calibration State - Allows the control of switching on or off the shunt calibration.

Shunt Calibration Value - This is the special shunt calibration value that should read 100.0 when shunt calibration is activated and the integrity of the calibration and hardware is correct.

Cal Info Tab

This tab shows the last date the Toolkit was used to perform calibration and shows the Calibration Counter parameter that the module increments whenever a calibration related parameter is written to.

The screenshot shows the 'Cal Info' tab in the LCA Toolkit software. At the top, there are settings for 'Input Sensitivity' (0.5 to 3.7 mV/V), 'Decimal Point' (199.99), and 'Mode' (LCA15 (Legacy)). Below these are tabs for 'Automatic', 'Table', 'Advanced', 'Shunt Calibration', and 'Cal Info'. The 'Cal Info' tab is active and displays the following information:

- Shows the stored last calibration date and calibration counters. If these parameters have not changed then the calibration of the device has not changed.
- Last Calibrated Date (By LCA Toolkit): 06 May 2014
- Calibration Counter: 125

At the bottom of the interface, there are several data fields:

- Underrange Value: 10.00000
- Overrange Value: 35.00000
- mV/V Input: 1.599434
- Calibrated Value: 25.59107
- Units: kg

The bottom status bar shows 'Reset', 'LCA20 Module serial number 999999999 set as station 253 on COM2', and 'Version: 1.0.2'. A 'Help' sidebar on the right provides instructions on how to calibrate the module.

Last Calibrated Date - Indicates the last date that calibration was performed by the Toolkit.

Calibration Counter - Shows the internal calibration counter.

Filters

This page allows the selection of filter settings that are applied to generate the **Gross value**.

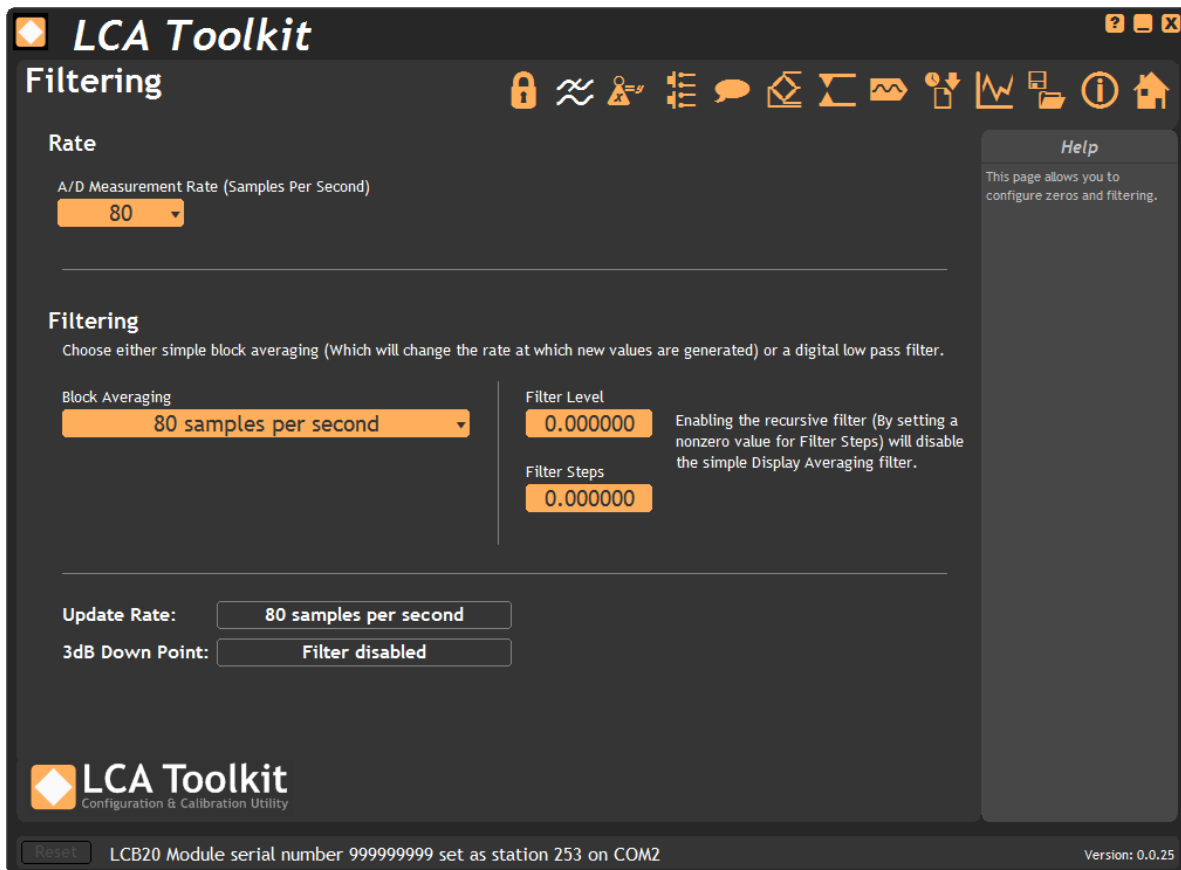

Rate - Here the basic selection of A/D measurement rate can be selected. The slower rate will have an improved noise free resolution.

Filtering - This section allows the choice between simple block averaging or digital low pass filtering. Choosing block averaging will slow down the generation of new values which will be noticeable on the optional display or via the communications bus. The digital low pass filter will result in new values being generated at the A/D measurement rate.

Block Averaging - Select the required rate at which new readings are generated. This is in the form of samples per second or seconds per sample.

Filter Level - If the difference between the newest unfiltered value and the previous filtered value is greater than this filter level value then the filter is bypassed and the gross will jump straight to the unfiltered value. If the difference is less than the filter level value then the filter will be operational.

Filter Steps - Set the fractional part of the difference between the newest and previous values that is added to the previous value to generate the next gross. i.e. if filter steps is 10 then only a 10th of the change is applied to the gross value.

Update Rate - This indicates the samples per second or rate at which new values are generated.

3db Down Point - When using the digital low pass filter there is an attenuation of higher frequency components on the input signal. This indicates the frequency at which the output value would be half of what it would be at a fixed level.



See Also - [Appendix B - Measurement | Filters](#) for more information.

Communications Protocols for Custom Software & Data Acquisition

If you intend to communicate with the LCA20 with custom software or to connect the module to a PLC or existing data collection system this section explains the various protocols available.

Communication Port

All Protocols use the serial settings which define the way the serial data is encoded. These are fixed and cannot be changed.

- One start-bit
- One stop-bit
- 8 data bits
- No parity

Bus flow control is managed as part of the protocol (managed differently by each).

No hardware or software flow control signals are to be used for any of the bus standards.

Protocols

The LCA20 supports a number of serial communications protocols and are explained below. All protocols except when in printer mode have a Master-Slave topology where the LCA20 is a slave device. The Master has control of the bus and is responsible for ensuring correct flow of messages on the bus, that is to say, waits for a response from the Slave device, if one is due, before transmitting other Master messages.

Note: This document refers to bits in the range of 0-7 or 0-15.

<i>Protocol</i>	<i>Type</i>	<i>2 Wire RS485</i>	<i>Advantages</i>	<i>Disadvantages</i>	<i>Notes</i>
MantraBus1	Proprietary	NO	Backward compatibility with Legacy products	1. Parameter data must be read as block. 2. Limited PC support available. 3. Not floating point format	Not recommended for new design.
MantraBus2	Proprietary	YES	1. Single parameters can be read. 2. Floating point format. 3. Lots of software support.	1. Not as efficient as data transmitted in nibbles.	
Modbus RTU	Standard	YES	1. Third party support for PC. 2. Direct connection to PLC that support Modbus.		Great for Labview. Registers must be read as pairs only.

<i>Protocol</i>	<i>Type</i>	<i>2 Wire RS485</i>	<i>Advantages</i>	<i>Disadvantages</i>	<i>Notes</i>
MantraASCII2	Proprietary	YES	1. Simple to write software for. 2. Can be used by a "Terminal" programme. 3. Easy to debug.	1. More data transmitted therefore slower. 2. Not checksum on data sent or received.	
Printer	ASCII data	NA	No software required, data sent on demand from digital input or continuous stream. Simple way of getting data into a PC	1. Can only be used on a one-to-one connection. 2. Data out only	Designed for Printers, ASCII Display modules

Software Command Reference for MantraBus2, Modbus and MantraASCII

The following table gives details of all LCA20 commands, with brief details of each.
Commands in Access Order

<i>Description</i>	<i>Access</i>	<i>MantraASCII Name</i>	<i>MANTRABUS2 command</i>	<i>MODBUS RTU Register</i>
Software Version	Read only	VER	1	40003
Serial Number low byte	Read only	SERL	2	40005
Serial Number high byte	Read only	SERH	3	40007
Status	Read only	STAT	4	40009
A-D Value	Read only	ADCF	5	40011
mV/V	Read only	MVV	6	40013
Calibrated Value	Read only	CALV	7	40015
Selected Display Value	Read only	DISP	8	40017
Snap Value	Read only	SNVA	9	40019
Peak	Read only	PEAK	10	40021
Valley	Read only	VALY	11	40023
Net Value	Read only	NET	12	40025
Gross Value	Read only	GROS	13	40027
Pre-Shunt-Cal Value	Read only	PSCV	14	40029
Calibration Change Counter	Read only	CALC	15	40031
Shunt Calibration Value	Read only	SCVL	16	40033
Analogue Output Force Counts	Read Write	AOFC	17	40035
Snap Value Selection	Read Write	SNGN	18	40037
System Zero	Read Write	ZERO	19	40039
Parameter Flags	Read Write	FLAG	20	40041
Setpoint 1	Read Write	SP1	21	40043
Inflight 1	Read Write	IF1	22	40045

<i>Description</i>	<i>Access</i>	<i>MantraASCII Name</i>	<i>MANTRABUS2 command</i>	<i>MODBUS RTU Register</i>
Setpoint 2	Read Write	SP2	23	40047
Inflight 2	Read Write	IF2	24	40049
Hysteresis	Read Write	HYS	25	40051
Output Action	Read Write	OA	26	40053
Low Calibration Value	Read Write	CALL	27	40055
High Calibration Value	Read Write	CALH	28	40057
Auto Tare	Read Write	AT	29	40059
Display Averaging	Read Write	DA	30	40061
Low Analogue Output Value	Read Write	OPL	31	40063
High Analogue Output Value	Read Write	OPH	32	40065
Decimal Point	Read Write	DP	33	40067
Communications Protocol	Read Write	CP	34	40069
Station Number	Read Write	SDST	35	40071
Log Number	Read Write	LN	36	40073
Display Resolution	Read Write	RS	37	40075
Low Calibration Value A-D mV/V	Read Write	ADCL	38	40077
High Calibration Value A-D mV/V	Read Write	ADCH	39	40079
Load Cell Sensitivity	Read Write	SENS *	40	40081
Measurement Rate	Read Write	RATE *	41	40083
Number of Calibration Points	Read Write	CALP	42	40085
Calibration Point 1: mV/V	Read Write	CMV1	43	40087
Calibration Point 2: mV/V	Read Write	CMV2	44	40089
Calibration Point 3: mV/V	Read Write	CMV3	45	40091
Calibration Point 4: mV/V	Read Write	CMV4	46	40093
Calibration Point 5: mV/V	Read Write	CMV5	47	40095
Calibration Point 6: mV/V	Read Write	CMV6	48	40097
Calibration Point 7: mV/V	Read Write	CMV7	49	40099
Calibration Point 8: mV/V	Read Write	CMV8	50	40101
Calibration Point 9: mV/V	Read Write	CMV9	51	40103
Calibration Point 1: Gain	Read Write	CGA1	52	40105
Calibration Point 2: Gain	Read Write	CGA2	53	40107
Calibration Point 3: Gain	Read Write	CGA3	54	40109
Calibration Point 4: Gain	Read Write	CGA4	55	40111
Calibration Point 5: Gain	Read Write	CGA5	56	40113
Calibration Point 6: Gain	Read Write	CGA6	57	40115
Calibration Point 7: Gain	Read Write	CGA7	58	40117
Calibration Point 8: Gain	Read Write	CGA8	59	40119
Calibration Point 9: Gain	Read Write	CGA9	60	40121
Calibration Point 1: Offset	Read Write	COF1	61	40123
Calibration Point 2: Offset	Read Write	COF2	62	40125
Calibration Point 3: Offset	Read Write	COF3	63	40127
Calibration Point 4: Offset	Read Write	COF4	64	40129
Calibration Point 5: Offset	Read Write	COF5	65	40131

<i>Description</i>	<i>Access</i>	<i>MantraASCII Name</i>	<i>MANTRABUS2 command</i>	<i>MODBUS RTU Register</i>
Calibration Point 6: Offset	Read Write	COF6	66	40133
Calibration Point 7: Offset	Read Write	COF7	67	40135
Calibration Point 8: Offset	Read Write	COF8	68	40137
Calibration Point 9: Offset	Read Write	COF9	69	40139
Select Analogue Output Range	Read Write	AOSL *	70	40141
4-20mA User Gain	Read Write	AOIG	71	40143
4-20mA User Offset	Read Write	AOIO	72	40145
0-10V User Gain	Read Write	AOVG	73	40147
0-10V User Offset	Read Write	AOVO	74	40149
Baud Rate	Read Write	BAUD *	75	40151
Label	Read Write	LABL	76	40153
Not yet implemented	Read Write	MODE	77	40155
Status of EEROM enable/disable	Read Write	EEDM	78	40157
Digital Input 1 function	Read Write	DIP1 *	79	40159
Digital Input 2 function	Read Write	DIP2 *	80	40161
Digital Input 3 function	Read Write	DIP3 *	81	40163
Filter Steps	Read Write	FFST	82	40165
Filter Level	Read Write	FFLV	83	40167
Default Display	Read Write	DDIS *	84	40169
Relay 1 Source	Read Write	RLS1 *	85	40171
Relay 2 Source	Read Write	RLS2 *	86	40173
Analogue Output Source	Read Write	ANOP *	87	40175
Hysteresis Relay 2	Read Write	HYS2	88	40177
Over-range Level	Read Write	OVRV	89	40179
Under-range Level	Read Write	UNDV	90	40181
Peak/Valley Source Selection	Read Write	PVGN	91	40183
Shunt-Cal Scaling Factor	Read Write	SCSF	92	40185
Zero Tracking Band	Read Write	ZTBD	93	40187
User Storage 1 (Toolkit Units)	Read Write	USR1	94	40189
User Storage 2 (Toolkit Units)	Read Write	USR2	95	40191
User Storage 3 (Toolkit Units)	Read Write	USR3	96	40193
User Storage 4 (Toolkit Cal Date)	Read Write	USR4	97	40195
User Storage 5 (Toolkit Lock-out))	Read Write	USR5	98	40197
User Storage 6	Read Write	USR6	99	40199
Reset	Command	RST	115	40231
Zero (tare)	Command	DOAT	116	40233
Latched Relay Reset	Command	LCHR	117	40235
Snap	Command	SNAP	118	40237
Reset Peak/valley	Command	RSPV	119	40239
Shunt Calibration On	Command	SCON	120	40241
Shunt Calibration Off	Command	SCOF	121	40243
Disable the EEPROM	Command	DAEP	122	40245
Enable the EEPROM to RAM	CMD	ENER	123	40247

<i>Description</i>	<i>Access</i>	<i>MantraASCII Name</i>	<i>MANTRABUS2 command</i>	<i>MODBUS RTU Register</i>
Enable the EEPROM from RAM	CMD	ENRE	124	40249

* See following table for multiple-option details



All Modbus accesses are in register pairs and 2 registers MUST be read

Multiple-Option Selection Table

This table shows the available value options for certain parameters listed in the table above.

<i>Command</i>	<i>Value</i>	<i>Function</i>
BAUD Baud rate	0	2400
	1	4800
	2	9600
	3	19200
	4	38k4
	5	57k6
	6	76k8
	7	115k2
SENS Load cell sensitivity	0	3.7-7.8mV/V
	1	0.5-3.7mV/V
RATE Measurement Rate	0	10sps
	1	80sps
AOSL Analogue output type	0	4-20mA
	1	0-10V
DDIS/RLAY/ANOP Display, relay and analogue output source	0	Net
	1	Gross
	2	Peak
	3	Valley
	4	Snap
DIP1/DIP2/DIP3 Digital input 1-3 assignment	0	Auto-tare
	1	Latched relay reset
	2	Print
	3	Default display
	4	Gross
	5	Net
	6	Peak
	7	Valley
	8	Snap
	9	Peak/Valley reset
	10	Shunt Calibration on
	11	Shunt Calibration off
	12	Shunt Calibration toggle
	13	Do Snap

MantraBus1

MantraBus1 is selected by setting the **Communications Protocol** equal to 128.

The protocol is HEX based meaning that it transmits and receives binary data in the range of 0 to 255 (**0xFFh**). The data is received and transmitted as signed 15 Bit form where the 15th bit is used to indicate polarity (not two's complement, see later)

To signify commencement of a new command, the HEX number **0xFFh** is used as a 'frame' character, followed by the **Serial Device Station number** of the unit under interrogation. The LCA20 will only act upon incoming data if its own **Serial Device Station number** immediately follows the **0xFFh** character. For MantraBus1 the **Serial Device Station number** has a range of 1 to 254.

New data must be received as a string of four nibbles (bits 7-4 set to zero) which are assembled into two bytes and written into the variables store within the LCA20. The most significant nibble must be received first and the last nibble *must* have the most significant bit (bit 7) set to indicate the end of data. This is followed by the checksum. The data transmitted from the LCA20 is always sent as complete bytes. The station number precedes the data and the checksum follows the data. The data format used is signed 15 Bit. The most significant bit of the most significant byte is set for negative numbers.

Operation

There are two modes of operation, namely data requests by the master controller and parameter writes. Data requests from the LCA20 consist of either a complete dump of the data variables stores in RAM or the Net value.

Parameter writes consist of writing new data to LCA20 variables, thus changing parameters such as Setpoints, Inflights etc. Parameter writes also include action commands such as Latch Relay Reset. After a parameter Write an acknowledgement message is returned by the LCA20 to indicate that the new data has been acted upon.

Writing to Parameters

The required parameter to be updated is determined by the command byte which follows the station number. An XOR (Exclusive OR) checksum consisting of the station number command byte and any following data must be appended to the data. It is most important that the byte preceding the checksum must have its most significant bit set to signify the end of data.

The LCA20 calculates its own checksum from the data it has received and, if it disagrees with the received one, a 'NAK' (not acknowledge) character is returned.

Command Table

The following is the list of commands available for reading from or writing to the LCA20.

Command Number		Description
Dec	Hex	
1	0x01h	Request all parameters includes Net Value
2	0x02h	Request Net Value
3	0x03h	Write Setpoint 1
4	0x04h	Write InFlight 1
5	0x05h	Write Setpoint 2
6	0x06h	Write InFlight 2

<i>Command Number</i>		<i>Description</i>
7	0x07h	Write Hysteresis
8	0x08h	Write Output Action
9	0x09h	Write mV/V for Low Calibration Point
10	0x0Ah	Write mV/V for High Calibration Point
11	0x0Bh	Write Calibration Low Value
12	0x0Ch	Write Calibration High Value
13	0x0Dh	Write Auto Tare
14	0x0Eh	Write Display Averaging
15	0x0Fh	Write Output Low
16	0x10h	Write Output High
17	0x11h	Write Decimal Point position
18	0x12h	Write Communication Protocol
19	0x13h	Write EEPROM Enable/Disable flag
20	0x14h	Do Relay Reset
21	0x15h	Do Auto-Tare
22	0x16h	Do Peak / Valley Reset

Command 1 (Read All)

Data transmitted to LCA20 for command 1:

0xFFh, Serial Device Station number, 0x81h, Checksum

Where Checksum = Serial Device Station number XOR with **0x81h**.

Example: To obtain a complete dump of the variables in the LCA20 whose Station Number is decimal 47 send the following Data:-

0xFFh, 0x2Fh, 0x81h, 0xAEh

|
Note MS Bit Set

Response to Command 1 from LCA20

<i>BYTE</i>	<i>Parameter</i>
1	Serial Device Station number
2,3	Net Value
4,5	Setpoint 1
6,7	InFlight 1
8,9	Setpoint 2
10,11	Inflight 2
12,13	Hysteresis
14,15	Output Action
16,17	mV/V for Low Calibration Point
18,19	mV/V for High Calibration Point
20,21	Calibration Low Value

<i>BYTE</i>	<i>Parameter</i>
22,23	Calibration High Value
24,25	Auto Tare
26,27	Display Averaging
28,29	Output Low
30,31	Output High
32,33	Decimal Point position
34,35	Serial Device Station number
36	EEPROM Enable/Disable flag
37	Relay status
38	XOR checksum of the above data

 Most significant byte precedes least significant byte for data sent by LCA20.

Command 2 (Read Net)

DATA transmitted to LCA20 for Command 2:

0xFFh, Serial Device Station number, 0x82h, Checksum

Where Checksum = Serial Device Station number XOR with **0x82h**

Example: To obtain the display reading of an LCA20 whose Serial Device Station number is decimal 47 send the following Data:

0xFFh, 0x2Fh, 0x82h, 0xADh

|
Note MS Bit Set

Response to Command 2 from LCA20

<i>BYTE</i>	<i>Parameter</i>
1	Serial Device Station number
2,3	Net Value
4	XOR checksum of the above data

 Most significant byte precedes least significant byte for data sent by LCA20.

If, when using commands 1 or 2, an error is detected by the LCA20 then it transmits the NAK (Not acknowledge) character.

Write Commands

Commands 3 To 18: Write Parameter to LCA20

Format for data transmitted to LCA20 for Commands 3 to 18:

0xFFh, Serial Device Station number, Command No, MSN, NMSN, NLSN, LSN, Checksum

Where:

- MSN = Most significant nibble of data
- NMSN = Next most significant nibble of data
- NLSN = Next least significant nibble of data
- LSN = Least significant nibble of data with MSBIT set
- Checksum = The following are XOR'd with each other:
Serial Device Station number, Command number, MSN, NMSN, NLSN, LSN with MSBIT set

Example:

To change SP1 to 200.0 whose Serial Device Station number is decimal 47. The following data is sent.

Please note the following points apply:
The decimal point is ignored i.e. 200.0 equals 2000 digits

2000 decimal is **0x07D0h**

The data is sent in Hex nibbles so 2000 = **0x00h, 0x07h, 0x0Dh, 0x00h**

The data transmitted by the master would be

0xFFh, 0x02Fh, 0x03h, 0x00h, 0x07h, 0x0Dh, 0x80h, 0xA6

|
Note MSBIT set

Response to Write Commands

If the data has been accepted by the LCA20 then the following acknowledgement string is transmitted by the LCA20.

Serial Device Station number, 0x06h (ASCII ACK character)

If there are any errors with the data received by the LCA20 then the following Not Acknowledgement (NAK) string is transmitted by the LCA20:-

Serial Device Station number, 0x15h (ASCII NAK character)

EEPROM commands



EEPROM commands are for backwards compatibility with LCA15 which had limited EEPROM write cycles. The LCA20 does not have this limitation and therefore EEPROM disabling is relevant only if an increase of speed is required or it is desirable that the LCA20 hold a set of known power up values.

When data is written to parameters the data is first entered into the RAM which is volatile memory (contents not saved through power cycle), if the EEPROM is not disabled then the data is also written into EEPROM which is the permanent non-volatile memory. This EEPROM memory has a limited number of write cycles and also requires time to write to. In systems where writes to parameters may be very high or speed of operation in terms of how long it takes to write data to memory and get an ACK (or NAK) returned from the LCA20 so the master can process the next read or write, then it is possible to disable the EEPROM memory.



If the EEPROM is disabled it is important to note that the next time the LCA20 is power cycled the LCA20 will revert to the last values that were stored in EEPROM and not the last values written by the communications port or from the keypad.

EEPROM disable is achieved by writing **0x100h** using command 19. In this state all writing to EEPROM is inhibited.

Example

To disable the EEPROM whose Serial Device Station number is set to decimal 47

The data transmitted by the master would be

```
0xFFh 0x2Fh 0x13h 0x00h 0x01h 0x00h 0x80h 0xBDh
```

The EEPROM can be re-enabled in two ways:

By writing **0x200h** via command 19.

This writes the current contents of the parameters stored in the RAM into the EEPROM.

To re-enable the EEPROM and update it with the new RAM data whose Serial Device Station number is set to decimal 47

The data transmitted by the master would be

```
0xFFh 0x2Fh 0x13h 0x00h 0x02h 0x00h 0x80h 0xBEh
```

By writing **0x400h** via command 19.

This updates the parameters stored in RAM from the current contents of the EEPROM.

To re-enable the EEPROM and update the RAM with the old EEPROM constants whose Serial Device Station number is set to decimal 47

The data transmitted by the master would be

0xFFh 0x2Fh 0x13x 0x00h 0x04h 0x00h 0x80h 0xB8

For response to these EEPROM commands see 'Response to Command 3 to 22' above.

Write Commands That Perform Actions

There are a number of commands that perform actions. These are similar to writing to parameters but do not necessarily have to contain data.

Command 20: Output Relay Reset

DATA transmitted to LCA20 for Command 20

0xFFh, Serial Device Station number, 0x94h, Checksum

Where Checksum = Serial Device Station number XOR with **0x94h**

Example: To output a relay reset to an LCA20 whose Serial Device Station number is set to decimal 47

The data transmitted by the master would be

0xFFh, 0x2Fh, 0x94h, 0xBBh

|
Note MS BIT SET

For response by LCA20 see 'Response to Commands 3 to 22' above

Command 21: Auto Tare

DATA transmitted to LCA20 for Command 21

0xFFh, Serial Device Station number, 0x95h, Checksum

Where Checksum = Serial Device Station number XOR with **0x95h**

Example: To output an Auto Tare command to an LCA20 whose Station Number is set to decimal 47

The data transmitted by the master would be

0xFFh, 0x2Fh, 0x95h, 0xBAh

|
Note MS BIT SET

For response by LCA20 see 'Response to Commands 3 to 22' above

Command 22: Peak Hold Reset

DATA transmitted to LCA20 for Command 22

0xFFh, Serial Device Station number, 0x96h, Checksum

Where Checksum = Serial Device Station number XOR with **0x96h**

Example: To output a Peak Hold reset to an LCA20 whose Serial Device Station number is set to decimal 47

The data transmitted by the master would be

0xFFh, 0x2Fh, 0x96h, 0xB9h

 |
Note MS BIT SET

For response by LCA20 see 'Response to Commands 3 to 22' above

MantraBus2

MantraBus2 is selected by setting the **Communications Protocol** equal to 131.

Mantrabus2 is a two-wire protocol which allows data to be transmitted & received over a common pair of wires. Communications traffic is synchronised by using a unique 8 bit framing character. For this reason the framing character must not appear as data in a command or reply from the responding LCA20. The protocol ensures this does not occur by splitting data bytes into 4 bit nibbles while the framing character & station number remain as 8 bit bytes.

Framing Character

The framing character for Mantrabus2 is **0xFEh**, (this is to differentiate it from the older Mantrabus1 **0xFFh** to allow the two protocols to be mixed on one bus).

Checksum

Both Host and Device send their XOR checksum of all data sent, excluding framing character, in nibble format with the MS nibble being first.

e.g. XOR Checksum of data is **0xA7h**. Checksum characters sent as **0x0Ah** and **0x07h**

Data Transfer

Data is both sent and received as 4 bytes split into 8 nibbles following the station number, plus two nibbles of checksum.



It is important that data sent to the device does not exceed the maximum or minimum value which can be displayed by the LCD programmer. For integer values this is between -19999 and 19999 for engineering unit's values this is determined by the decimal point position. For example. If the LCA20 has a Decimal Point position of 3 then the largest value that can be written is 199.99 and the smallest value is -199.99.

Floating-Point Data Format

All data sent & received in Mantrabus2 is in the IEEE floating-point format, this being a 4-byte floating-point number. The byte containing the sign & exponent is sent first, with the LS byte of the mantissa being last.

The memory layout of the 4-byte floating-point numbers is:

MSB	31	Sign bit ,	1=negate
	30-23	Exponent,	7-bit excess-127
LSB	22-0	Mantissa,	23-bit fraction with implicit 1

The value of the number is thus

$$\{ (-1)^{\text{Sign}} * 2^{(\text{Exponent}-127)} * 1.\text{Mantissa} \},$$

Note the 'assumed 1' before the mantissa. The exception to this is the special value 0.0, which is represented as 4 zeroes.

So a floating-point number of -12345.678 is represented as

0xC6h, 0x40h, 0xE6h, 0xB6h

This is represented in nibble format as -

0x0Ch, 0x06h, 0x04h, 0x00h, 0x0Eh, 0x06h, 0x0Bh, 0x06h

End of Data Identifier

As the protocol has no fixed length or length identifiers the last nibble of data sent to the device has its MS nibble set. This indicates to the module device that all data has been received & the next two bytes will be checksum data.

So the above data with MS nibble set would read

0x0Ch, 0x06h, 0x04h, 0x00h, 0x0Eh, 0x06h, 0x0Bh, 0x86h

This does not apply to the response from the module as the master knows how many bytes to expect in the reply to each of its commands.

ACK & NAK

Mantrabus2 supports ACK and NAK, sending ACK (**0x06h**) at the end of a successful operation, and NAK (**0x15h**) for an unknown command or failed operation. These are always preceded by the station number (see examples below).



Mantrabus2 will *not* transmit a NAK for invalid checksum data, but instead remains silent. (This is different from the behaviour of the older Mantrabus1).

Writing to Parameters

Station number and command number are followed by 8 bytes of nibble data (the last having its MS bit set), followed by the two checksum nibbles.

To write the value 100.0 to variable **SP1** (command number decimal 21) at station decimal 47, send the following

(Floating point 100.0 = **0x42h, 0xC8h, 0x00h, 0x00h**)

0xFEh	0x2Fh	0x15h	0x04h	0x02h	0x0Ch	0x08h	0x00h	0x00h	0x00h	0x80h	0x0Eh	0x08h
DATA. Note most significant bit of last byte set											Checksum	
Command												
Serial Device Station number												
Frame character												

The response is then - Serial Device Station number' + 'ACK'

0x2Fh, 0x06h

Reading of Parameters

To read an individual parameters, the command number is sent with the MS bit set (i.e. no data following).

To read *OPH* (command number decimal 32) from Serial Device Station number decimal 47, send the following -

0xFEh	0x2Fh	0xA0h	0x08h	0x0Fh
		Checksum		
		Command. Note Most Significant bit of last byte set		
		Serial Device Station number		
Frame character				

Assuming the current value of OPH is -123.45

Which in floating point format is represented as **0xC2F6E66h**

0x2Fh, 0x0Ch, 0x02h, 0x0Fh, 0x06h, 0x0Eh, 0x06h, 0x06h, 0x06h, 0x02h, 0x00h

Action Commands

These are transmitted like read commands, i.e. no data sent. The response is identical to write commands.

To Reset (RST = command decimal 115) at Serial Device Station number decimal 3, send the following.-

0xFEh	0x03h	0xF3h	0x0Fh	0x00h
		Checksum		
		Command. Note Most Significant bit of last byte set		
		Serial Device Station number		
Frame character				

The response is then - Serial Device Station number + 'ACK'.

0x03h, 0x06h

Modbus

MODBUS is selected by setting the **Communications Protocol** equal to 132.

MODBUS is a proprietary standard of Modicom Inc.

The full specification is quite complex, including a timeout-based framing strategy and polynomial CRC calculation, so full details are not given here. Refer to Modicom documentation. Knowledge of the MODBUS protocol is therefore assumed.

The MODBUS protocol is a partial implementation of the "RTU" (binary) form of the MODBUS standard, sufficient to allow LCA20 units to coexist on a serial bus with other MODBUS-compliant devices.



Third-party applications for MODBUS communications are readily available (e.g. ModScan from Win-Tech software, www.win-tech.com, who offer a free trial version).

Modbus Messages

All messages and responses are formatted with a checksum according to the normal RTU rules. The slave number is the Serial Device Station number: Slave '0' may also be used for broadcast writes.

The device command-set is mapped into the MODBUS 'Output' or 'Holding Registers' -

Parameters (read or write) are mapped onto a pair of registers containing a 4-byte floating-point value

Action Commands are implemented as dummy parameters: Writing activates the command and reading returns a dummy value (with no action)

Only Two Valid Message Function Codes Are Supported

Function 03 'Read Holding Registers' - to read a register-pair

Function 16 'Preset Multiple Registers' - to write a register-pair

The start address must always be a valid parameter address, which is always an odd number (see the following).



The *only* permitted data length is two registers, i.e. 4 bytes.

Registers *cannot* be read or written singularly, in larger groups or using other addresses (i.e. even-numbered registers cannot be addressed directly).

Parameter Addresses

See the [Software Command Reference](#) table for Modbus register numbers

Parameter Values

All exchanged values (read and write parameters) are in the standard IEEE 4-byte floating-point format:

The 32 bits of the number are distributed as follows

MSB	31	Sign bit ,	1=negate
	30-23	Exponent,	7-bit excess-127
LSB	22-0	Mantissa,	23-bit fraction with implicit 1

The value of the number is thus

$$(-1)^{\text{Sign}} * 2^{(\text{Exponent}-127)} * 1.\text{Mantissa}$$

Note the 'assumed 1' before the mantissa. The exception to this is the special value 0.0, which is represented as 4 zeroes.

So a floating point number of -12345.678 is represented as

0xC6h, 0x40h, 0xE6h, 0xB6h

These 32 bits are mapped onto a register pair in the following way: The lower register holds bits 15-0 and the upper register bits 31-16.

These values are coded according to normal MODBUS conventions, so the actual byte sequence in a read/write message is thus -

R1_{hi}, R1_{lo}, R2_{hi}, R2_{lo}

- Which in terms of bits is-

15:8, 7:0, 31:24, 23:16

Error Codes

Only Three Modbus Error Codes Are Supported, Which Are Used As Follows

01 'Illegal Function' request for function other than 3 or 16

02 'Illegal Data Address' attempt to read an unsupported register address

03 'Illegal Data Value' attempt to write a read-only parameter, or message too long for buffer (valid messages have a known maximum length)

Write Command Example

Write value 1.23 to Calibration High Value (CALH) to registers 57, 58 on Device ID 4.

1.23 in floating point format is represented as **0x3F9D70A4h**

Data transmitted by Master

0x04h	0x10h	0x00h	0x38h	0x00h	0x02h	0x04h	0x70h	0xA4h	0x3Fh	0x9Dh	0x6Bh	0xABh
		Starting Register		Number of Registers		Data				Checksum		
		Function code										
Device ID												

A correct LCA20 response would then be

0x04h	0x10h	0x00h	0x38h	0x00h	0x02h	0xC0h	0x50h
		Starting Register		Number of Registers		Checksum	
		Function code					
Device ID							

Read Command Example

Read the Setpoint value (SP1) from registers 43, 44 on Device ID decimal 57

Data transmitted by Master

0x39h	0x03h	0x00h	0x2Ah	0x00h	0x02h	0xE1h	0x7Bh	
Device ID	Function code	Starting Register				Number of Registers		Checksum

A Correct Response from a LCA20 with a SP1 Value of 12.34 (0x414570A4h) would then Be

0x39h	0x03h	0x04	0x70h	0xA4h	0x41h	0x45h	0xE9h	0x70h
Device ID	Function code	Length				Data		Checksum

Execute Command Example

Execute Relay Reset command using registers 235,236 on Device ID decimal 57.

These commands are same as write commands except the data sent is irrelevant and in the example below data is sent as 0 which is represented as 0x00000000h.

Data transmitted by Master

0x39h	0x10h	0x00h	0xEAh	0x00h	0x02h	0x04h	0x00h	0x00h	0x00h	0x00h	0xA8h	0xF8h	
Device ID	Function code	Starting Register				Number of Registers		Data Length			Data		Checksum

A correct LCA20 response would then be

0x39h	0x10h	0x00h	0xEAh	0x00h	0x02h	0x64h	0x84h	
Device ID	Function code	Starting Register				Number of Registers		Checksum

MantraASCII2

MantraASCII2 is selected by setting the **Communications Protocol** equal to 133.

The ASCII protocol uses only printable characters and carriage-return ('<CR>'), which allows a "dumb" terminal device or a PC programme like Hyper-Terminal to interrogate the device.

Host Command Message Format

The command request structure is shown in the following example, illustrating the message write 123.45 to parameter Setpoint 1 (SP1) on Serial Device Station number 1.

```
!001:SP1=123.45<CR>
```

Framing Character	Station Address	Separator	Command Identifier	Access Code	Data	End of frame
!	001	:	SP1	=	123.45	<CR>

An explanation of each field is as follows:

- **Framing Character:** A "!" character is used to signal the start of a new message. This character is only ever transmitted by the host, for framing purposes.
- **Station Address:** A three-digit ASCII decimal number (0-999), determining which slave device(s) the command is intended for. All three digits must be sent. Address 000 is reserved for broadcast addressing.
- **Separator:** Always present. As no checksum or message verification technique is used, slaves use this as an extra check on message validity.
- **Command Identifier:** Up to 4 alpha-numeric characters, case insensitive, giving the name of the required command.
- **Access Code:** Defines what sort of response is expected :-
 - '=' means write data is expected to follow
 - '?' means the host is expecting to receive read data back
 - <CR> (i.e. nothing more before end) means the command is an action type
- **Data:** An ASCII decimal-formatted number, can include 0..9, '+', '-', '.', and spaces. This field can have a maximum length of 15 characters



It is important that data sent to the device does not exceed, ignoring the decimal point position, values greater than 32767 or less than -32768 otherwise the internal storage of these values will be corrupted.

- **End of frame:** A <CR> is always present to indicate the end of the message

Summary

- A command message begins with '!', followed by a three-digit station address, then a ':', and finishes with a <CR>.
- The '!' and <CR> *only* appear at the beginning and end of commands respectively

- From the ':' to the final <CR> is the command 'instruction' (of read, write or execute type)
- All instructions begin with an alphanumeric command identifier of up to 4 characters, and end with a non-alphanumeric (which may be the final <CR>).

Slave Response Message Formats

Each slave monitors the bus for command messages. It responds to any message that is addressed to it by sending a response message.

To be accepted by a slave device, a message must start with '!', the correct three-digit slave address and ':', and end with <CR>, with no intervening extra '!'.
The slave will then *always* respond.

There are three possible types of response: acknowledge (ACK), acknowledge with data (for a read), and not-acknowledge (NAK)

1. ACK is a single <CR> character. This confirms an action or write command.
2. ACK-with-data is a decimal number, followed by <CR>. This confirms a read and returns the data value.
3. NAK is an '?' <CR> sequence. The device rejected the command.

There are several possible reasons for a NAK response.

- Command identifier not recognised.
- Badly formatted command such as missing command identifier, unrecognised access-code character, or unexpected character somewhere else
- Access attempted not supported by this command.

NOTES:

- From receipt of the host's terminating <CR> to a response from the device (if any) will be at most 50mS. After this, it can be assumed there is no response.
- There is no value-checking: A slave cannot NAK a command because a write data value is 'unsuitable' in some way, only if write access itself is disallowed.

For the Ack-with-data (i.e. a successful read command), the returned value consists of printable ASCII characters finishing with a <CR>, formatted according to the DP.

Write Command

If the device accepts the command then a <CR> is transmitted. There is no error checking on the data received by the device.

Example:

A command to set the BAUD parameter to three on Serial Device Station number 1 would look like this -

```
!001:BAUD=3<CR>
```

Assuming a device with **Serial Device Station Number 1** is present, it will respond with -

```
<CR>
```

Read Command

Returns the requested value specified by the command.

The returned value is formatted according to the Decimal Point (DP). The response consists of a sign character (\pm), 5 characters for the value, a decimal point, and a terminating <CR>:

The length of the response is thus fixed as follows.

For integer values or engineering values with no decimal point 7 characters are sent

For engineering values with a decimal point 8 characters are sent

Examples:

A command to read the Display value (DISP) output will look like this -

```
!001:DISP?<CR>
```

If the display value = 32.1 and the Decimal Point (DP) = 3 , then the response string will be -

```
+032.10<CR>
```

A command to read the Low Pass Filter Steps (FFST) output which is an integer value will look like this -

```
!001:FFST?<CR>
```

If the value = 20, then the response string will be -

```
+00020<CR>
```

Action Command

If the device accepts the command then a <CR> is transmitted.

Example:

A command to reset Serial Device Station number 14 will look like -

```
!014:RST<CR>
```

The response string will be just -

```
<CR>
```

Broadcast Commands

If the station address in a command message is "000", this means a broadcast command.

All slaves act as normal on a broadcast command, but do not respond. Broadcast commands are either write or action commands.



Broadcasts commands DO NOT yield responses.

Example:

A command to all devices on the bus to sample their inputs using the SNAP command will look like this -

! 000 : SNAP <CR>

There is no response!

Bad Commands

If any command is not understood by the device then a "?" is transmitted followed by a <CR>.

Example:

A unrecognised command, correctly addressed to Serial Device Station 173 -

! 173 : XYWR? <CR>

produces the general error response -

? <CR>

The LCA20 will not send responses to the following

- Unavailable station number
- Data outside of limits.

Using a Printer or Remote display

Printer selection is made when Communications Protocol (CP) is set between 1 - 127

Printer selection enables the LCA20 to print its selected display value (**ddiS**) to a printer via its communications port. This display value can be assigned a log number (**Ln**) depending on the user set options entered under Communications Protocol (CP). The log number can be reset or pre-set using the mnemonic (**Ln**). This number will increment on each trigger giving a unique printout number. This number will reset to zero after 19,999. The value is not saved on power fail. A label (**Lab**) can be appended to the printed display value. A large range of labels are available to the user (see below).



The printer is electrically isolated from the Strain Gauge input by virtue of the LC4 Communications Port.

Selecting the Printer functions

The Communication Protocol Parameter (CP) sets the format of the printout and whether the output is on demand by contact closure or a continuous output stream. The value of CP to be entered is the algebraic sum of the following components:-

Printer on demand	= 1
Inhibit log number	= 2
Inhibit line feed	= 4
Streaming output	= 64



Streaming output sends a new string to the communications port at the same rate the display is updated.



For backwards compatibility with LCA15 a Communications Protocol (CP) value of 127 gives the equivalent functionality as a value of 64.

Example 1: Streaming printer output with no log number = $64 + 2 = 66$ - set 'CP' to 66 - outputs a continuous ASCII stream of the display data transmitted on every display update.

Example 2: Print via contact closure on digital input with no line feed = $1 + 4 = 5$.

Label Parameter

Selects the appropriate unit of measurement from the following table.



A value of 0 means NO LABEL

<i>Value</i>	<i>Label</i>	<i>Value</i>	<i>Label</i>	<i>Value</i>	<i>Label</i>
0	BLANK	29	gram	58	mA DC
1	Deg R	30	kg	59	V AC
2	Deg C	31	lb	60	mV AC
3	Deg F	32	kWh	61	A AC
4	Kelvin	33	mile/h	62	N
5	lb/in ²	34	%	63	mm/s
6	bar	35	ton	64	gals
7	mbar	36	%Dev	65	mins
8	kPa	37	W	66	litres
9	atm	38	kW	67	knots
10	mmHg	39	MW	68	s
11	inHg	40	pH	69	hours
12	inH ₂ O	41	ppm	70	Nm
13	cmHg	42	uS	71	PSI
14	mm	43	Ohms	72	g
15	Wh	44	m/s	73	Counts
16	dB	45	ft/min	74	P
17	tonne	46	RPM	75	Chan. 1
18	m	47	RPMx10	76	Chan. 2
19	in	48	RPMx100	77	Chan. 3
20	ft	49	cos @	78	Chan. 4
21	degrees	50	km/h	79	Chan. 5
22	L/s	51	ms	80	Chan. 6
23	L/min	52	RPM1000	81	Chan. 7
24	L/h	53	Hz	82	Chan. 8
25	gals/s	54	kHz	83	Chan. 9
26	gal/min	55	V DC	84	Chan.10
27	gal/h	56	mV DC		
28	%RH	57	A DC		

Format of Output String

The ASCII String for both Printer and continuous output is in the same format and is shown below for the following settings.

CP = 1, dP = 3, Lab = 30

```
00159 +100.23 Kg<CR><LF>
```



In the above example the length of ASCII string will vary with the choice of Label

For a continuous ASCII output to a large LED display which does not require a Line Feed Character <LF> and where no Log Number (Ln) or Label (LAb) is required.

CP = 70, dp = 2, Lab = 0

```
+10.023<CR>
```

Installation

Mechanical

LCB20 Board Module

The LCB20 is the PCB only element of the LCA20. The board can be bought and fitted to OEM products or a customer particular case. Care should be taken when installing the PCB to ensure good ESD precautions are taken and to also ensure against risk of electrocution when mains powered or mains relay switching.

The PCB has four mounting holes suitable for M3 bolts.

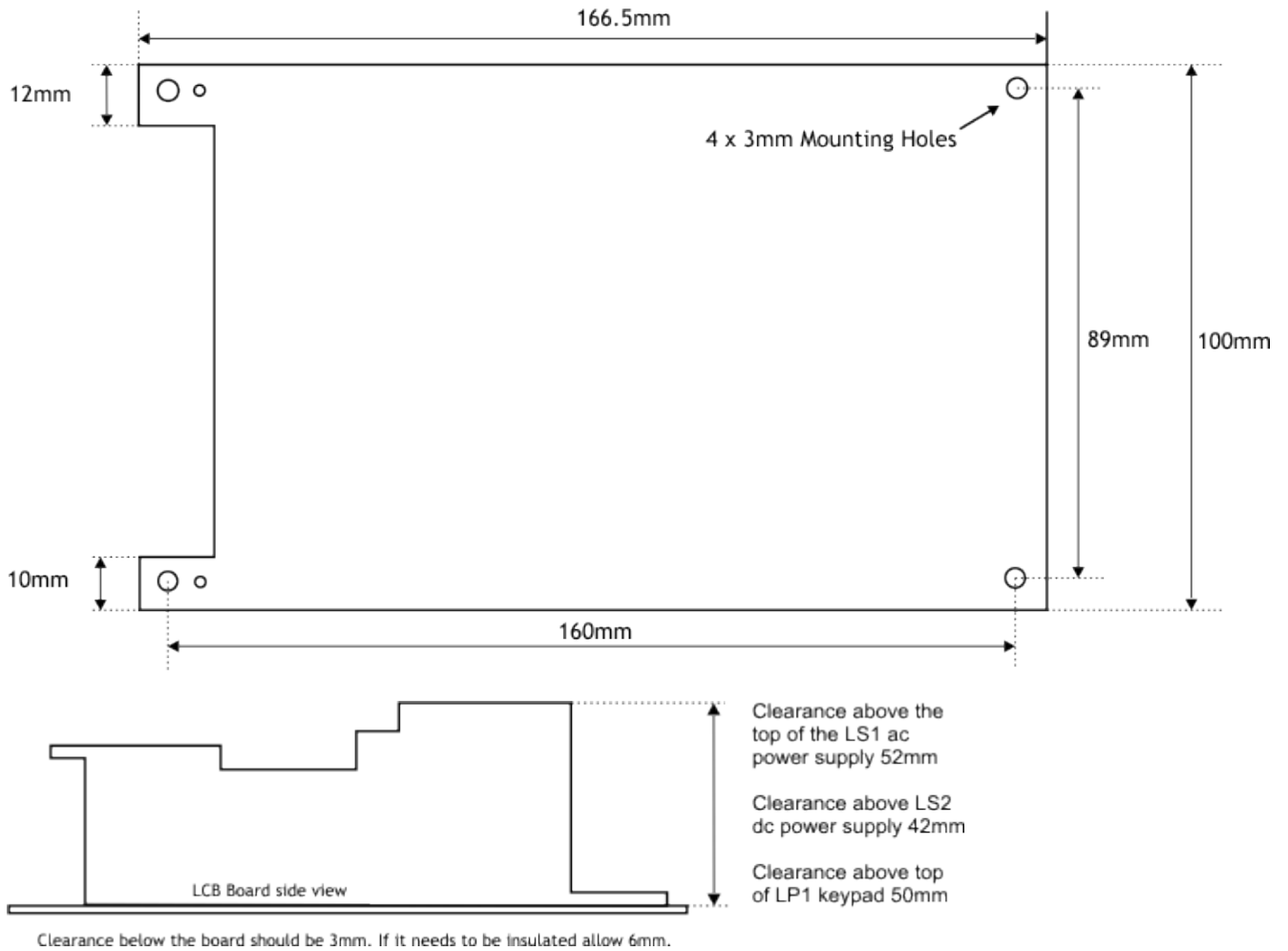

LAC ABS Case

The LAC is an ABS case fitted with 6 off plastic glands which accept cable sizes from diameter 4.5mm to 7mm. Three of these glands have sealing plugs fitted. There are four mounting holes which allow the unit to be fixed to a surface whilst maintain the IP rating.

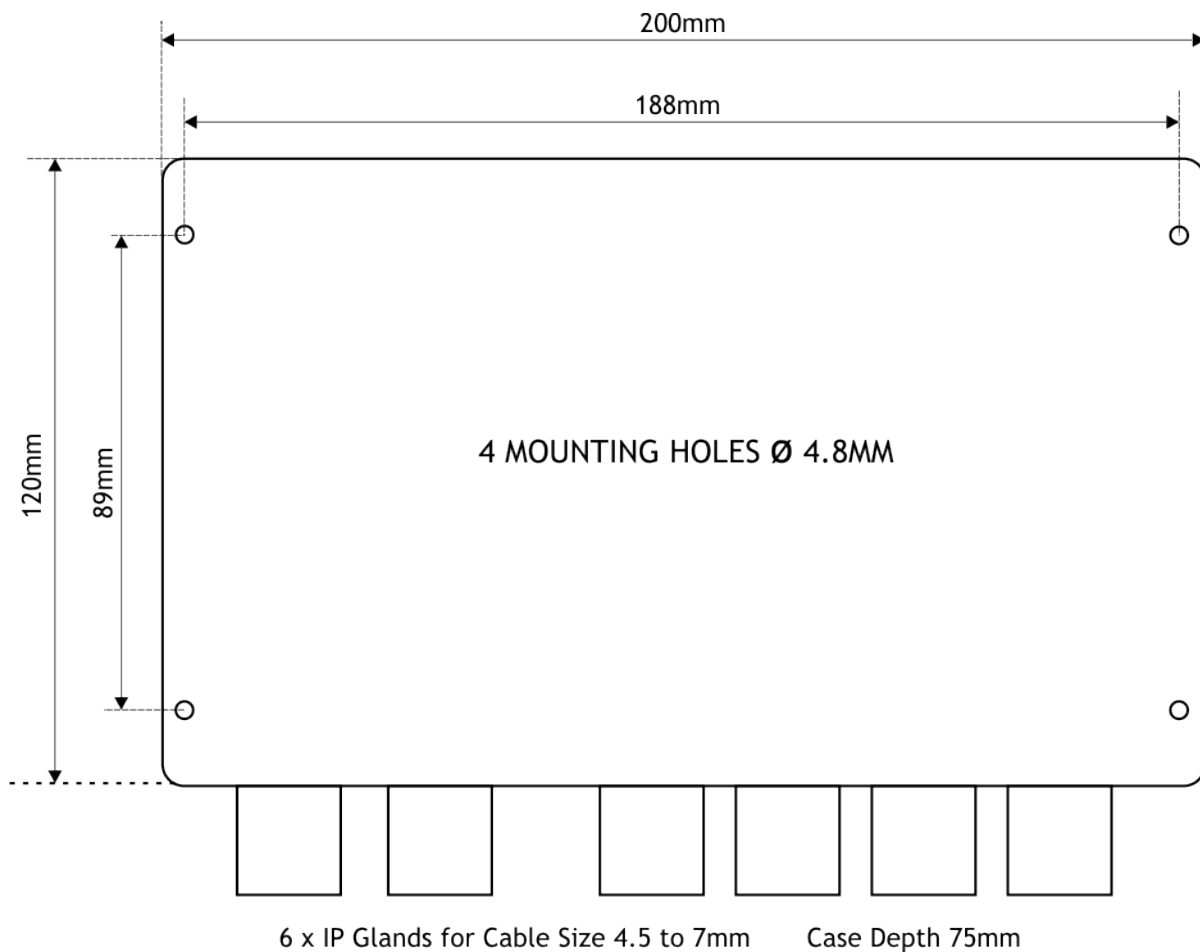

LTL Transparent Lid

The LTL is a clear perspex lid which is fitted to the LAC. It is mainly used when the On-board programmer (LP1) is fitted to the LCB20 PCB.

LSS Stainless Steel Case

The LSS is an optional Stainless steel enclosure suitable for catering and pharmaceutical applications. This unit has 6 plastic cable glands of which 3 have sealing plugs fitted. In the bottom of the box is a fibreglass base plate for mounting the LCB20.

An earth stud M6 x 16mm is provided on the base of the case with an M4 x 6mm on the internal surface of the lid of the case.



Where mains voltages are connected to the LCA20 then the unit must be suitable earthed

This case has no surface mounting holes provided.

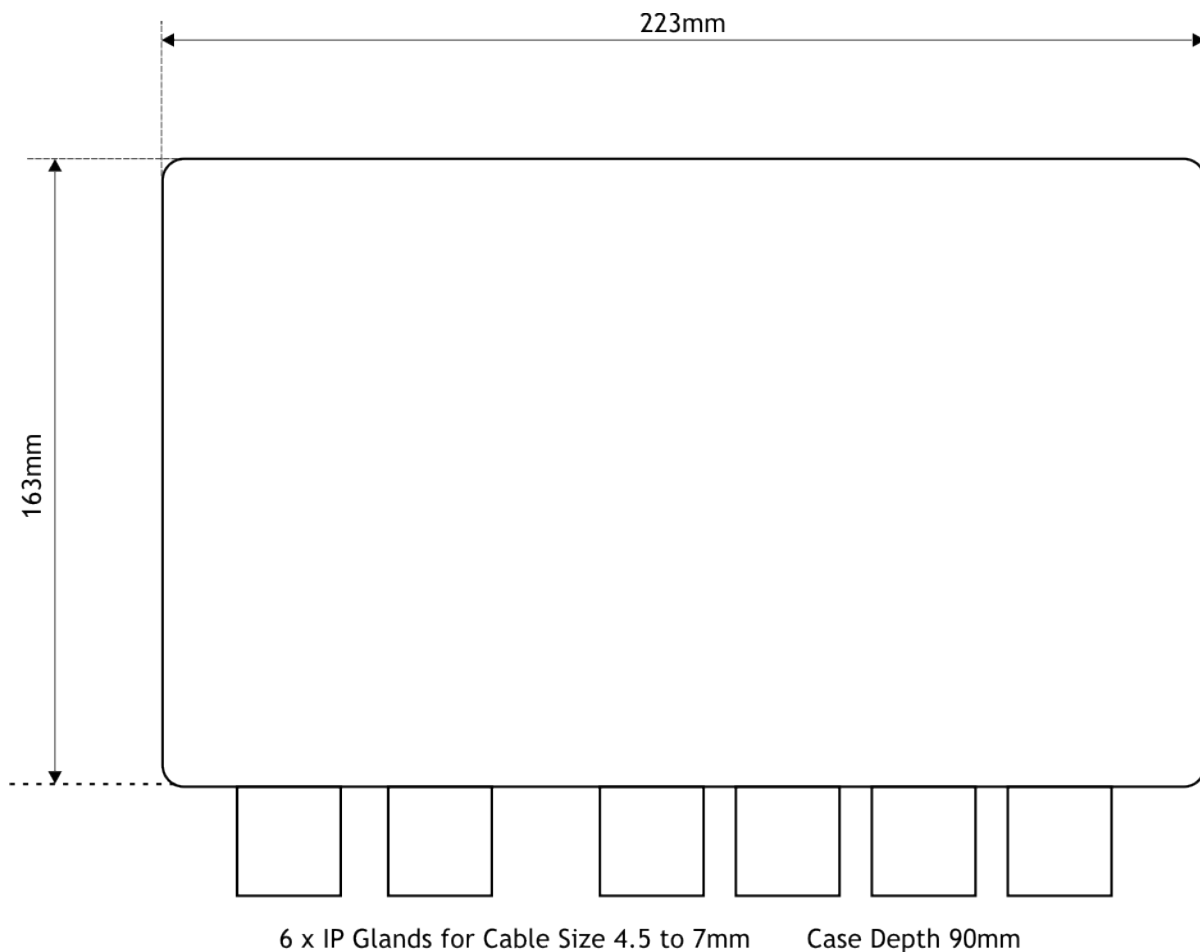

LDC Die Cast Case

The LDC is an optional Die cast enclosure suitable for more industrial applications. This unit has 6 plastic cable glands of which 3 have sealing plugs fitted. In the bottom of the box is a fibreglass base plate for mounting the LCB20.

The lid has a tapped hole for earthing the lid to the base.



Where mains voltages are connected to the LCA20 then the unit must be suitable earthed

Similar to the LAC, this case has four mounting holes which allow the unit to be fixed to a surface whilst maintain the IP rating.

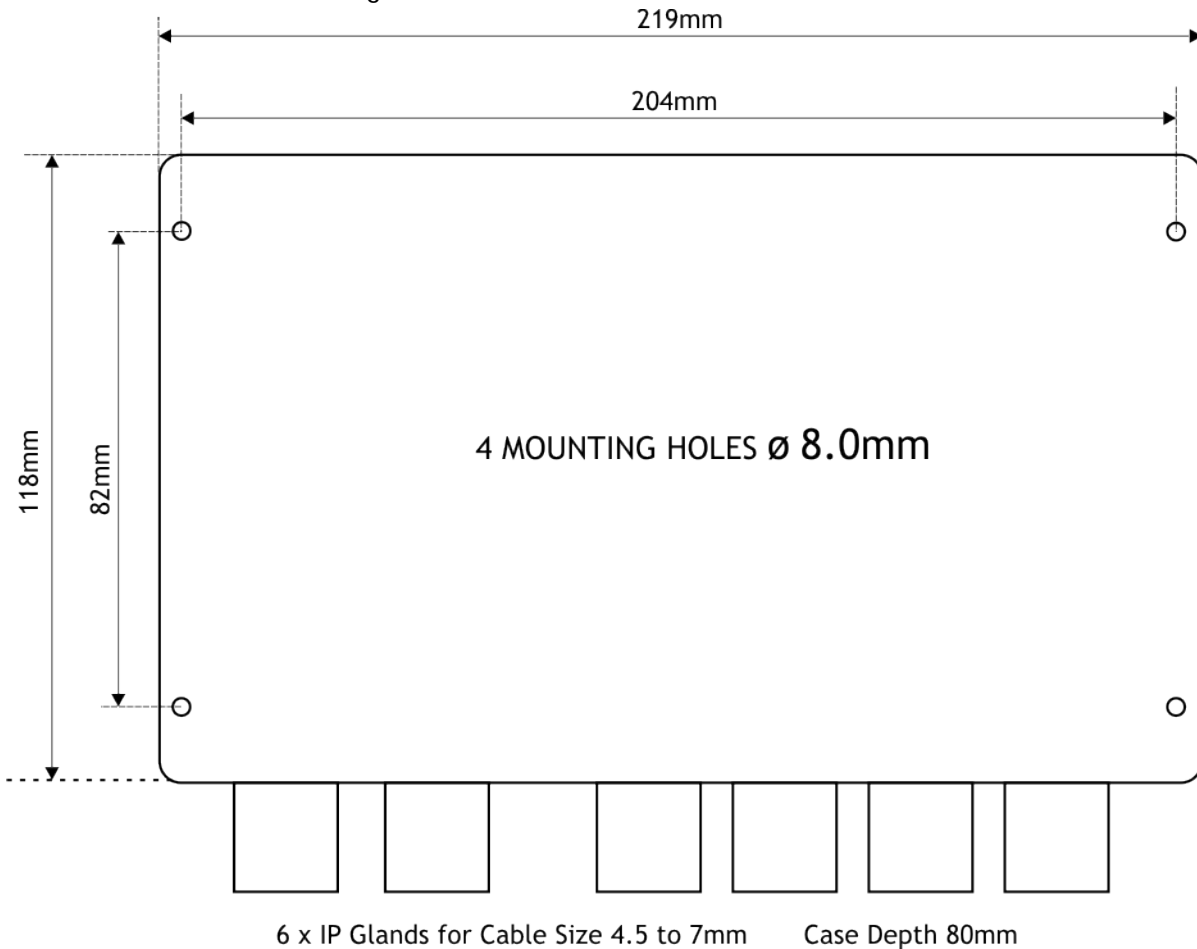

D2 DIN Rail

This DIN rail mounting option accepts a LCB20 board assembly for Top Hat type DIN rails. If these parts are purchased separately then the copper parts of the LCB20 board fingers require cutting off.

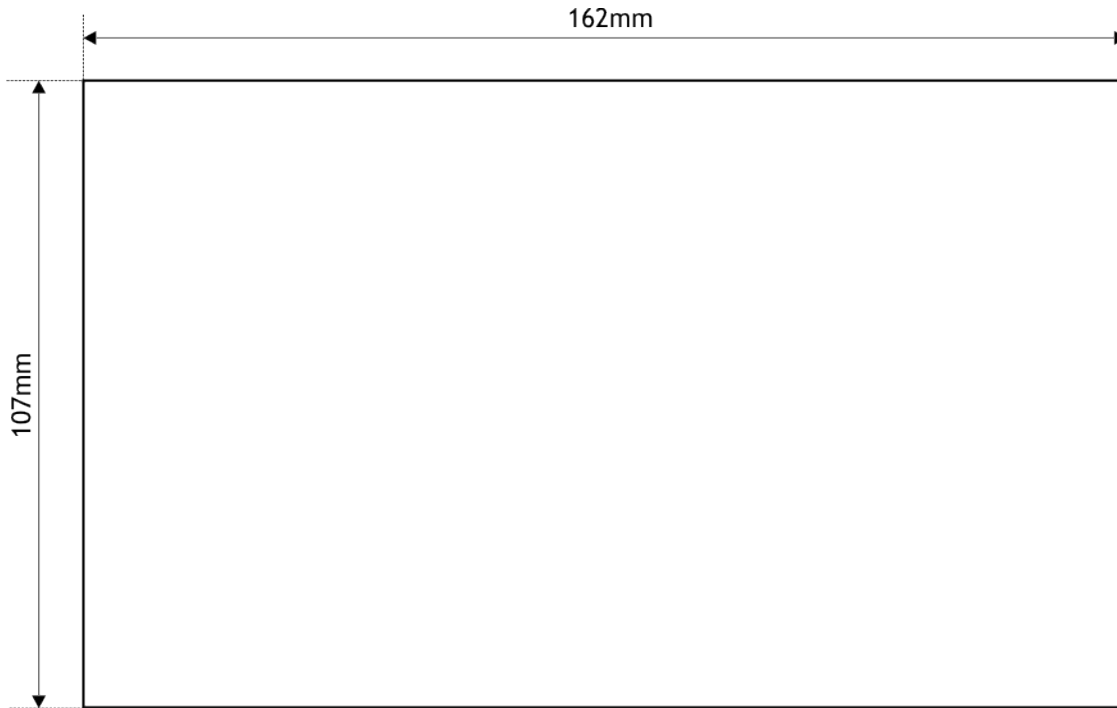

Max height above DIN Rail Mounting surface = 100mm. Fits ALL carrier rails DIN/EN 35

Connections

Programmer Modules

There are two types of programming modules available. Both have 4 keys for menu navigation and a 4½ digit LCD display. The LP1 is an On-board programmer which is permanently fitted to the LCA20. The LP2 is a hand held programmer that can be used to setup and calibrate the LCA20 and then removed leaving a blind amplifier/controller.

Both fit into the FCC68 6 way connector marked on the PCB as **J8**.

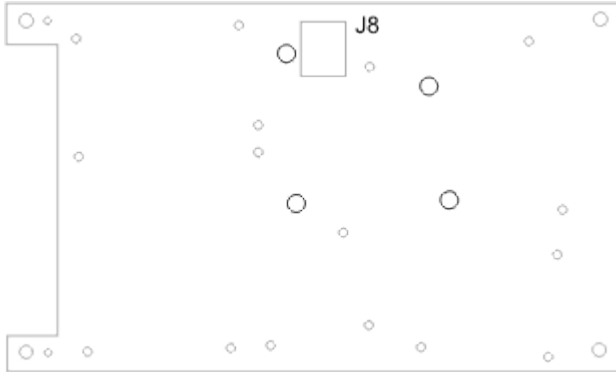

LP1

The on-board programmer is fitted by first connecting the FCC68 6way connector and then pushing the four nylon pillars into their respective holes on the LCA20 PCB, care must be taken not to damage any of the surrounding surface mount components when doing this.

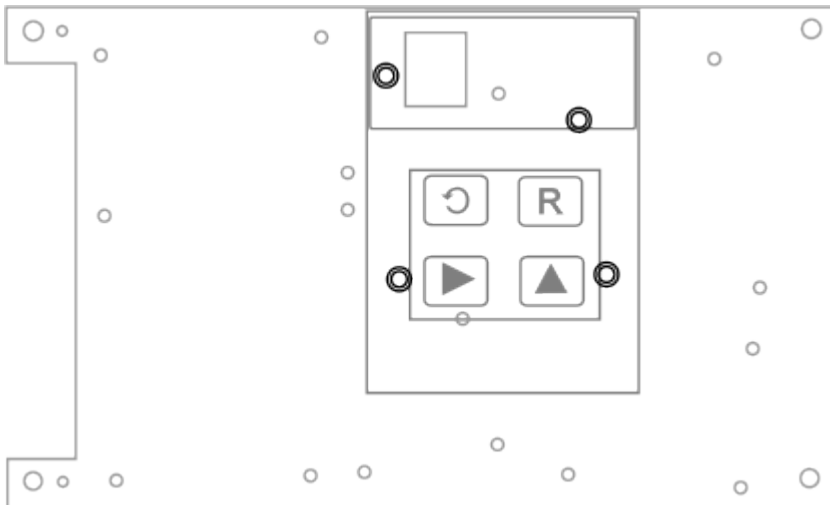

LP2

The handheld programmer comes with 2m of cable. Power should be switched off before the connector is inserted or removed.

Power Supplies

There are two choices of power supply available, the LS1 is for mains powering and the LS3 for DC powering. Both power supply options provide isolation between the incoming supply, the load cells and digital inputs and to the analogue output.

The power supplies provide the following nominal voltages.

<i>Description</i>	<i>Nominal Voltage</i>	<i>J11 Pin number</i>
Power supply monitor	-12V unregulated	1
Logic and Load cell excitation	+5V	2
Additional Relay supply	-5V	3
Common for above supplies	0V	4
Not connected	Not Applicable	5
Analogue output	+24V unregulated	6
Analogue output	-5V	7
Analogue output common	0V	8

Note Pin 1 of J11 is at the end furthest in board.

LS1 Mains Supply

The LS1 allows for powering of both 110 and 230VAC mains voltages and at frequency of both 50Hz and 60Hz.

The maximum power requirement is 10W. The unit should be fused with a suitable device.



If the LCA20 is housed in a metal enclosure such as LDC or LSS then the enclosure must be earthed in accordance with the relevant regulations.



The cover plate supplied with the LS1 and LS3 must be fitted after connections have been made.

Fitting Module to Main Board

The module fits to the main board by plugging the white connector on the underside of the LS1 module into J11 on the main board. One nylon pillar engages into a hole on the main board. Three metal pillars are already mounted on the main board and the LS1 module should be screwed to these.



The LS1 is shipped with a yellow link wire fitted ready for 230VAC operation.

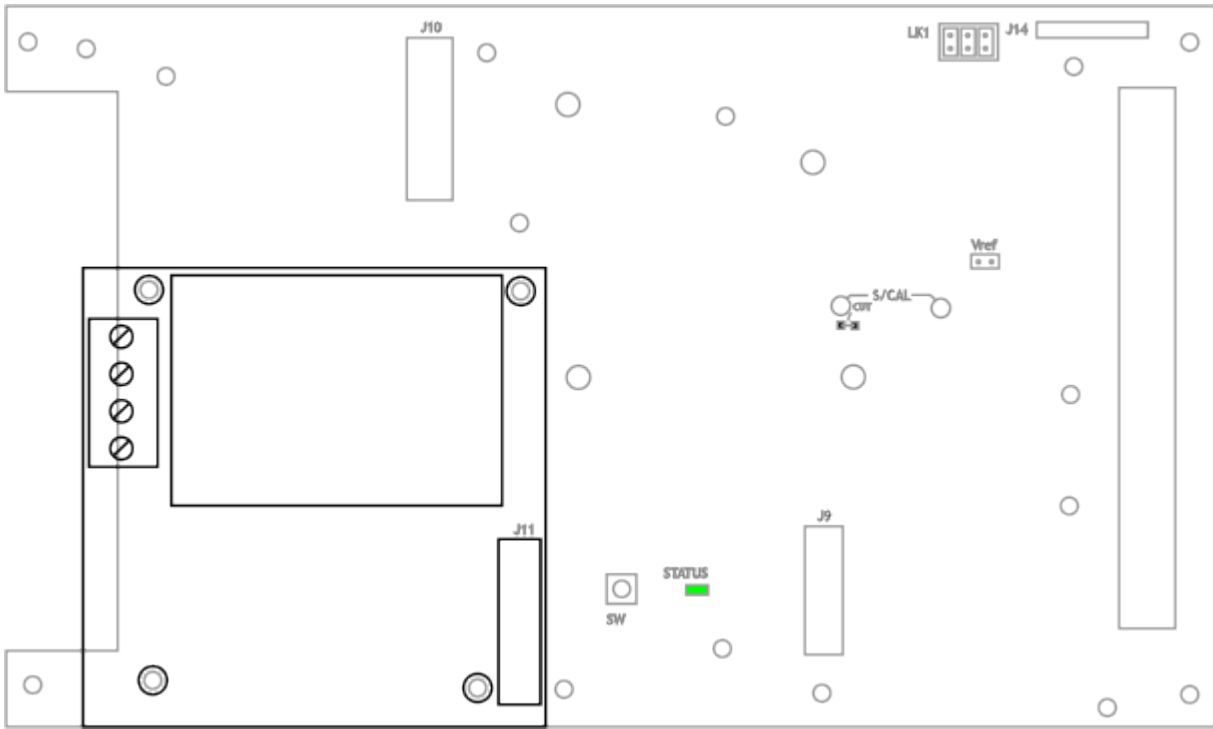

Supply Connections

97VAC to 120VAC

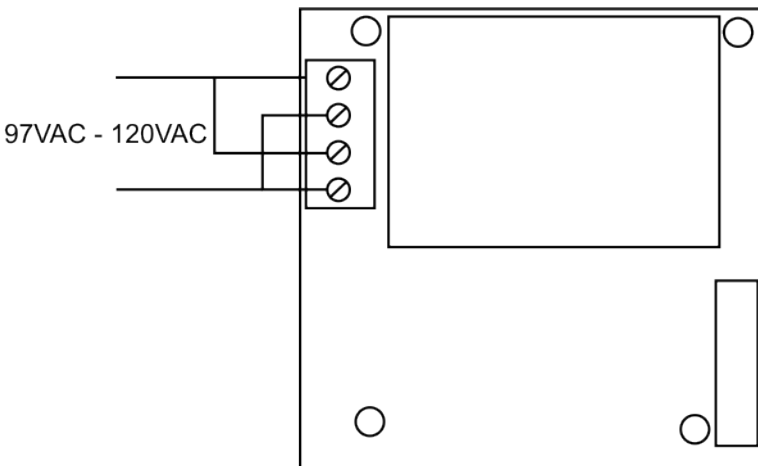

210VAC to 260VAC

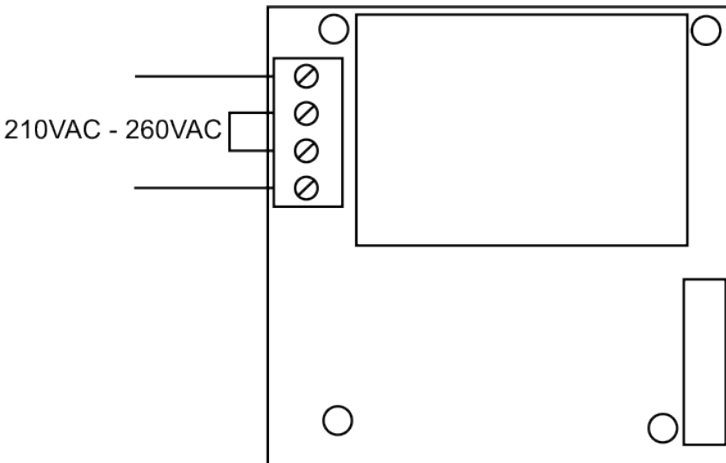

LS3 DC Supply

The LS3 accepts DC voltages from 9 to 32VDC. The DC source must be able to supply a start-up current of 3A for 20mS. The power requirements once started is a maximum of 10W.



It is recommended that an anti-surge fuse be used to protect the LCA20.



The cover plate supplied with the LS1 and LS3 must be fitted after connections have been made.

Fitting Module to Main Board

The module fits to the main board by plugging the white connector on the underside of the LS3 module into J11 on the main board. Four nylon pillars also engage into the four hole positions shown. If metal pillars are fitted to the main board, these will need to be removed first.

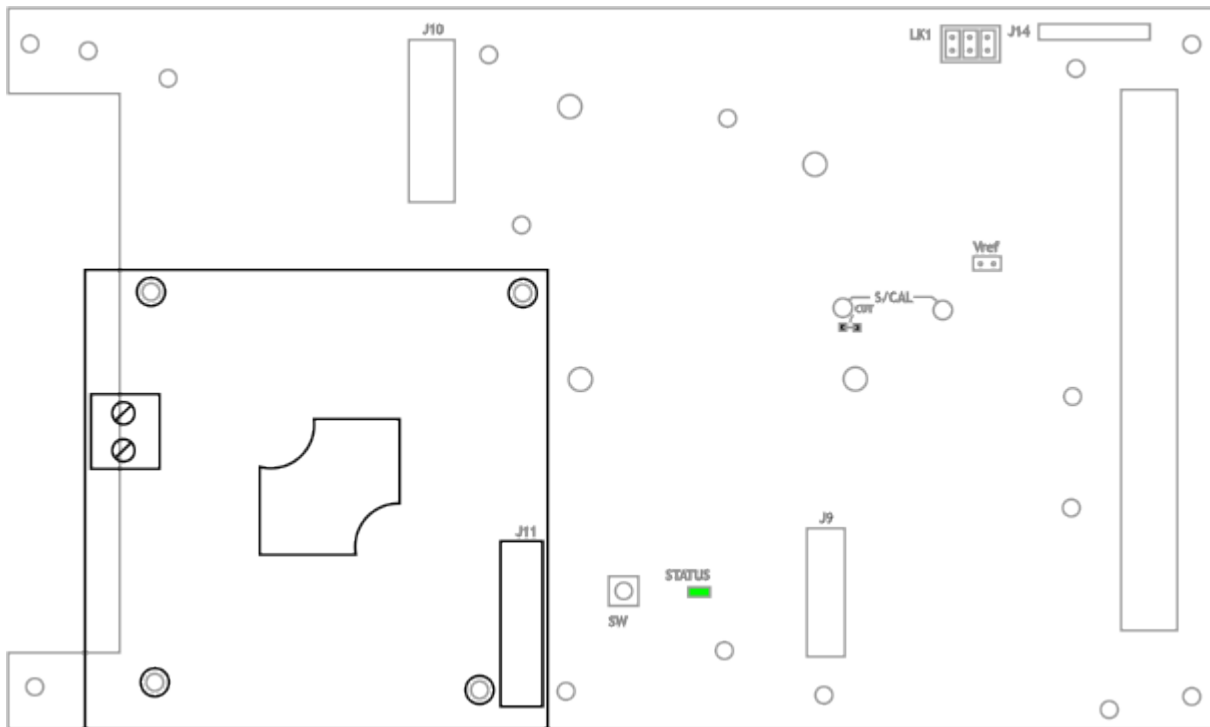

Supply Connection

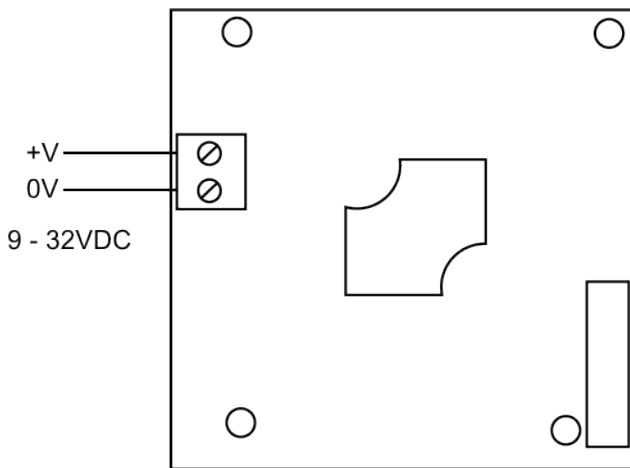

Load cell Connections

The LCA20 offers a direct connection to a range of low level (foil) strain gauge sensors.

Gain sensitivity is optimised for two ranges, 0.5 to 3.7mV/V and 3.7 to 7.8mV/V selected by the **Sensitivity** parameter in the menu.

A stable 5VDC excitation supply at 150mA is provided which is sufficient to power up to ten 350 ohm load cells connected in parallel.

Ratiometric strain gauge measurements are taken which cancel out errors caused by changes or drift in Excitation voltage. The LCA20 facilitates 6 wire measurement which allows for voltage drops caused by long cable lengths between the LCA20 and the load cells, where barriers are used or if the load cells are powered from another source. Where possible, use 6-wire connections to the load cells.

For load cell connections we recommend the use of 3 pairs of twin twisted pair cable such as Alpha Wire 5123C SL005 available from Farnell 130-2249.

The pairs should be arranged as follows:

Excitation	pins 1 & 6
Sense	pins 2 & 5
Signal	pins 3 & 4



Terminate all screens at 'SCR'. The screens should not be connected at the transducer end of the cables. However, if the transducer has an EMC gland then the screen should be connected there and not at 'SCR' on the LCA20.

Connector Location

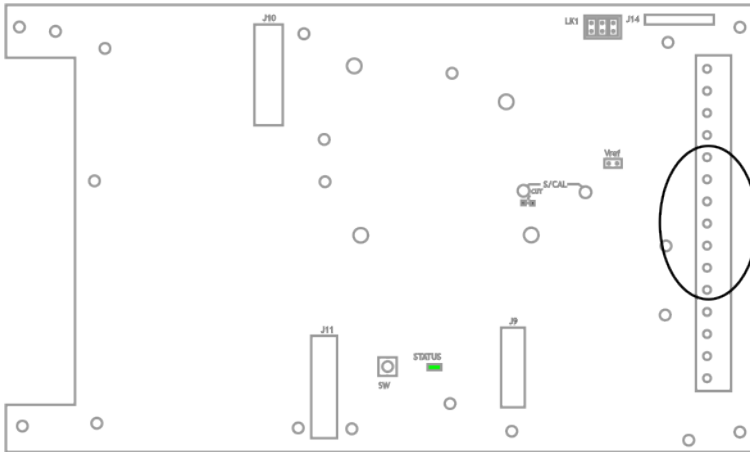

4 Wire

If the load cell is supplied with a 4 wire cable and long cable lengths are required it is recommended that any extension cabling required is 6 wire to compensate for voltage drops along the cable.

Once a 4-wire system is calibrated any changes to the cable length will require that the system is re-calibrated.

Please refer to load cell manufacturer's instructions.



When 4-wire connectivity is used it is important that the respective Excitation and Sense connections are linked together.

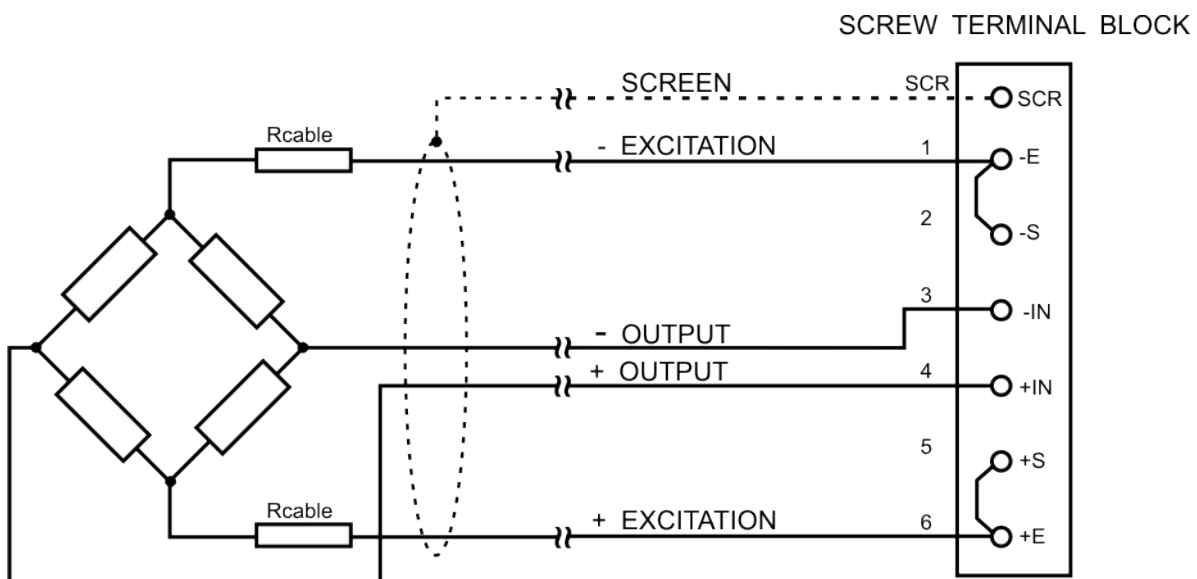

6 Wire

Where load cells are provided with 6 wires then it is recommended to continue the 6 wires connectivity throughout the system.

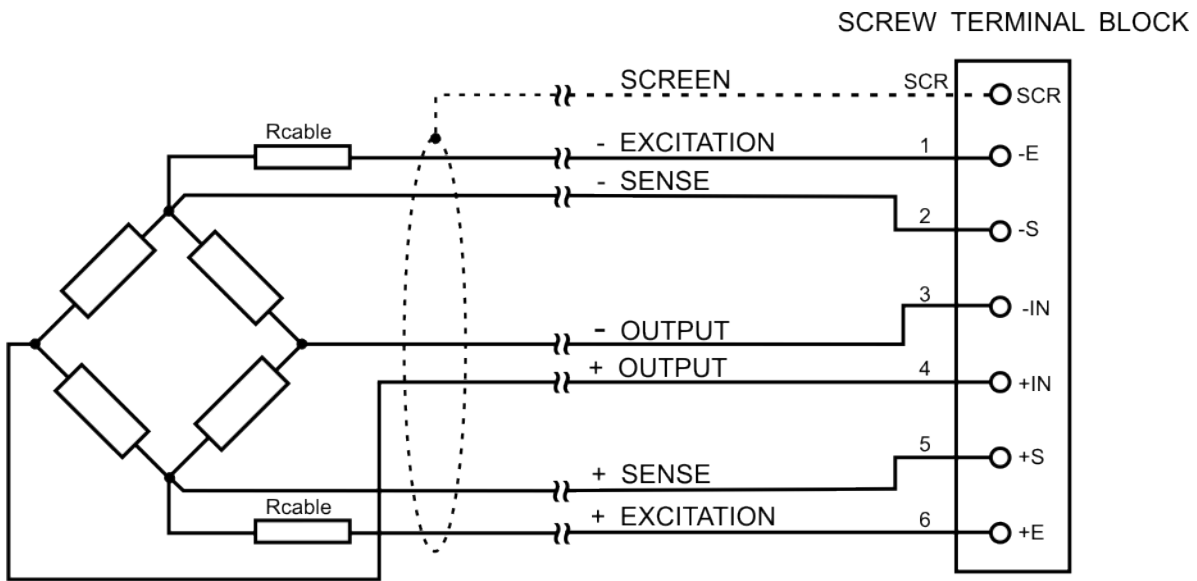

Barriers

The LCA20 can be used with isolating barriers. This allows the load cells to be situated in the hazardous area whilst the LCB is in the safe area.
6 wire connectivity must be used.

The example below uses Pepperl + Fuchs isolated barriers.

KFD2-VR2-Ex1.50M is used to isolate the Output signal from the load cell.

KFD2-VR-Ex1.18 is used to isolate the Sense connections.

KFD0-SD2-EX1.1065 used to provide excitation for up to 4 350 ohm load cells.

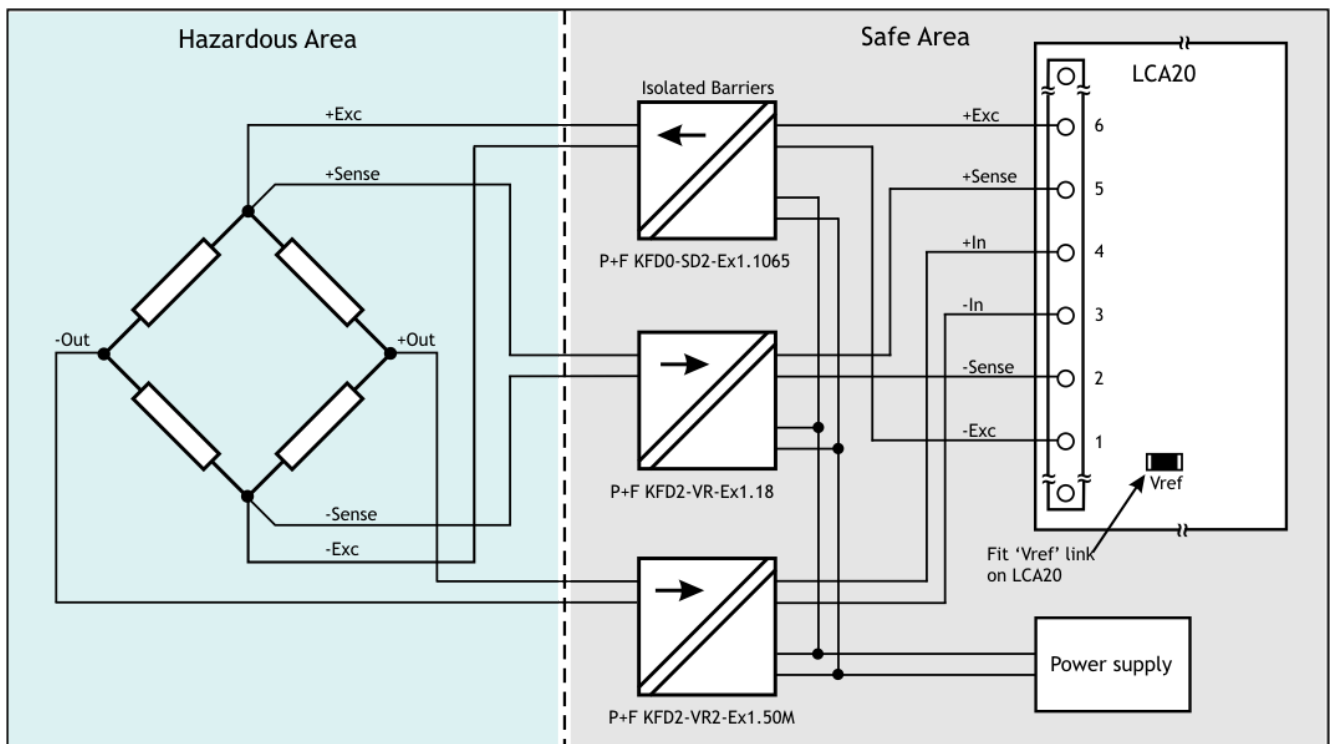

Because the barriers are fully isolated, the Vref link MUST be fitted to ensure that the LCA20 input stage is biased correctly.



If galvanic isolation is NOT required, passive non-isolated barriers such as the MTL77xx series can be used instead. In this case the Vref link should NOT be fitted.

Digital Inputs

The digital inputs are for switch contacts or volt free transducers such as relays. Another common type that is suitable for the LCA20 digital inputs is a NPN open-collector transistor.

The digital input internal circuitry has 1k ohm pull-up with a 300ms de-bounce filter. The common of the digital input marked '0V' has a 47 ohm series resistor.

i The Digital Inputs are not isolated from the load cell input

! Do not apply voltages to these digital inputs

Connector Location

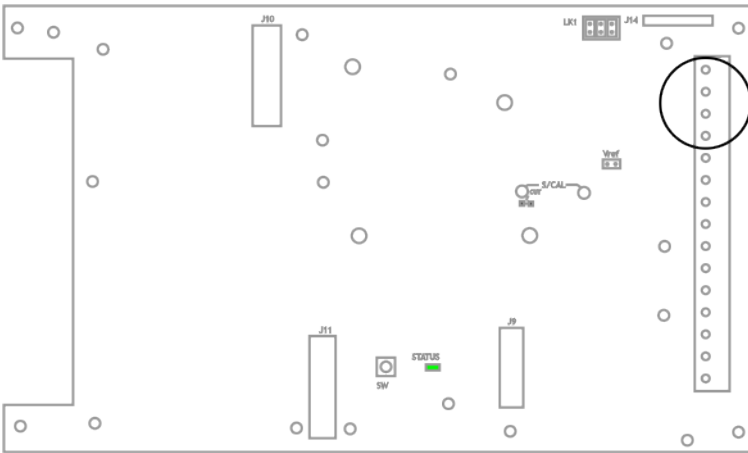

Connections

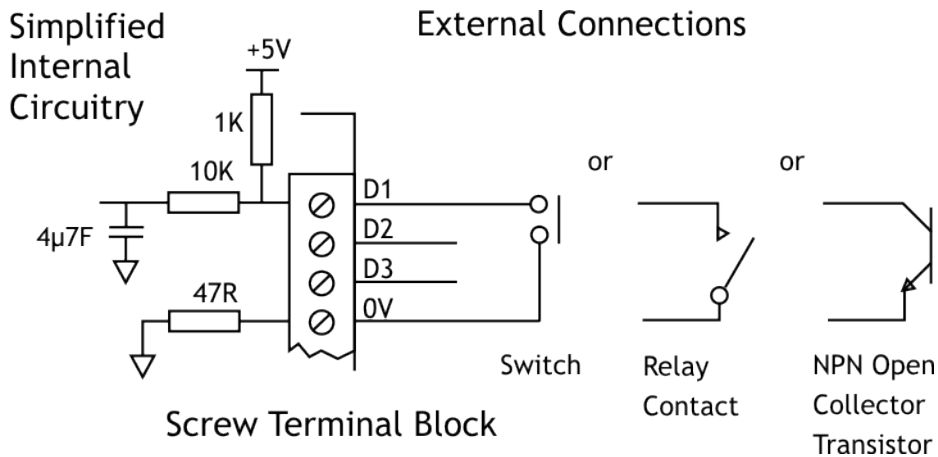

Analogue Output

There are two analogue output available on the LCA20, a 0-10V voltage and a 4-20mA current. They are both driven from a single Pulse Width Modulated (PWM) source meaning they track each other and use the same scaling factors.

The analogue outputs are isolated from the load cells, digital inputs and power source but are common to each other.

We recommend using a cable with a screened twisted pair such as ALPHA WIRE - 5121C available from Farnell stock code 130-2298.

The screen should be connected at either the LCA20 or the remote device but not both thus avoiding ground loops.

Connector Locations

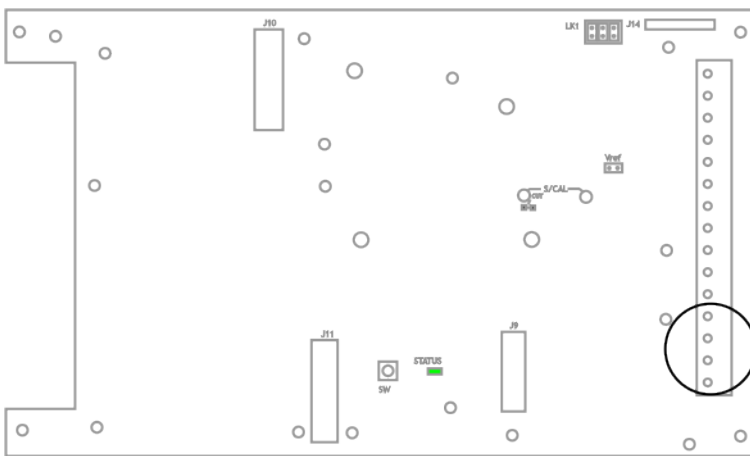

Voltage

For voltage output the cable lengths should be kept to less than 20m. Voltage outputs are more susceptible to electrical interference so where long cable lengths are required the current output should be used.

If the screen is to be connected at the LCA20 then it should connect to the terminal marked -V.



Minimum load impedance for the voltage output is 5k ohms

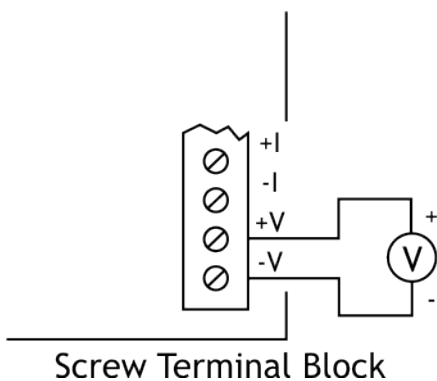

Current

The current is suitable for driving long cable lengths and in areas where higher electrical interference is likely.

If the screen is to be connected at the LCA20 then it should connect to the terminal marked -V.



The maximum load impedance for the current output is 1k ohm

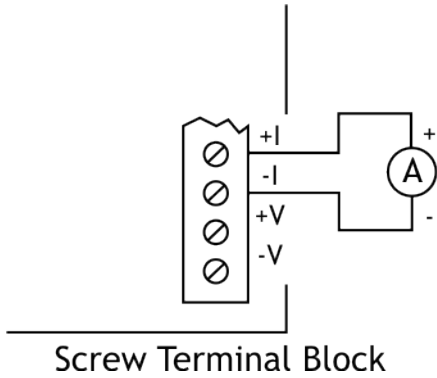

Relay Module LR1

The Relays provide for 5 amp switching at 240VAC. Suitable cable for the installation should be selected.



Care should be taken as any connections already made by the installer may be at mains potential.



Ensure the cover plate re-fitted to the LS1 or LS3 after installation.

Fitting Module to Main Board

The module fits to the main board by plugging the white connector on the underside of the LR1 module into J10 on the main board. Three nylon pillars also engage into the three hole positions shown.

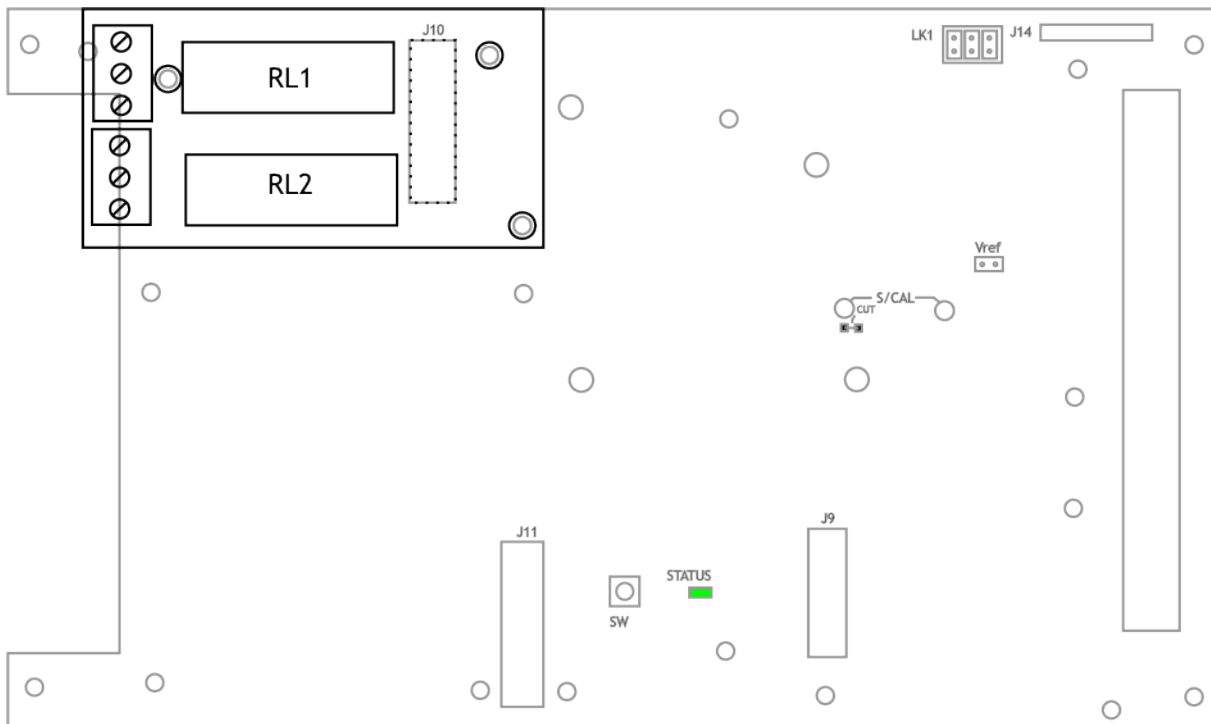

Contact Connections

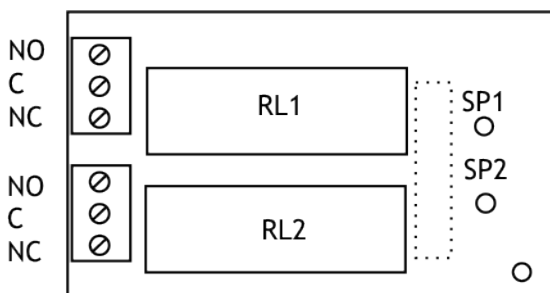

The LEDs marked SP1 and SP2 will illuminate when the relay is energised.

Communications Module LC4

The optional LC4 communications module acts as a two-way data link for the LCA20 providing an electrically isolated multi-standard interface.



The Isolation is rated as a maximum $\pm 130\text{V}$ RMS or DC to analogue input or any other port.



Maximum cable length is dependent on cable used, baud rate and electrical environment.

Fitting Module to Main Board

The module fits to the main board by plugging the white connector on the underside of the LC4 module into J9 on the main board. Two nylon pillars also engage into the two hole positions shown.

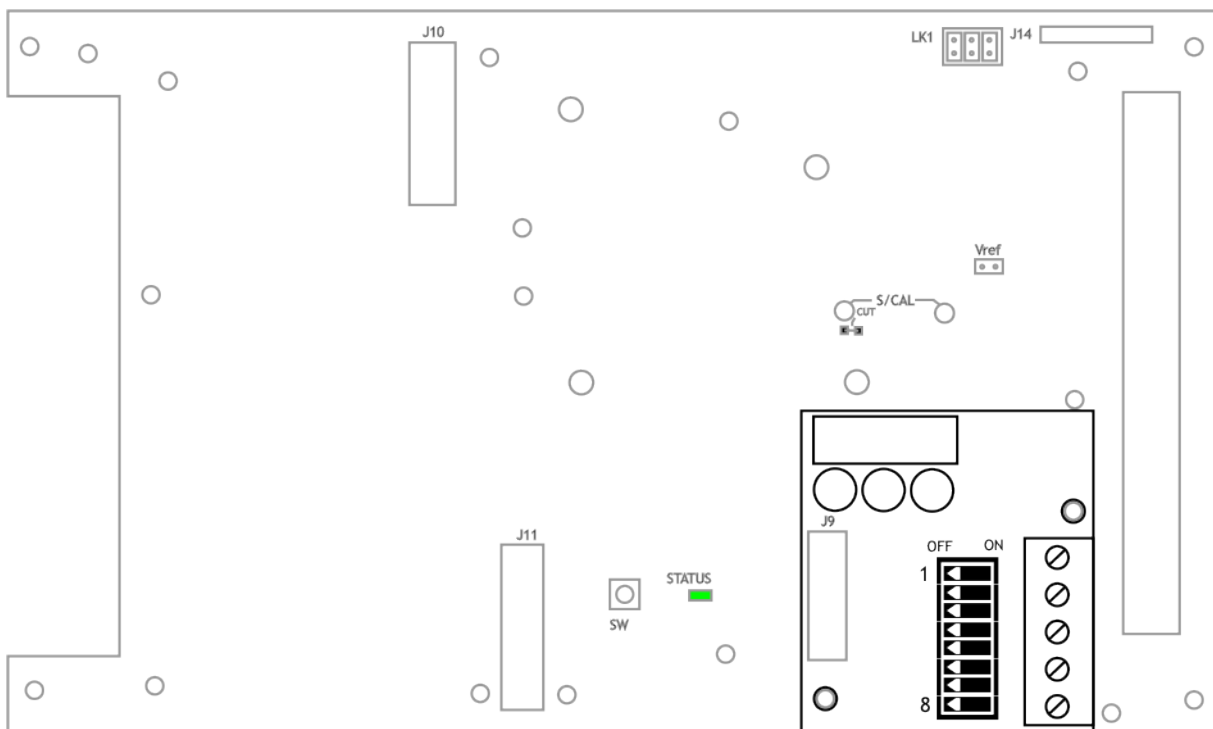

RS232

RS232 is for a one to one connection. i.e. only one LCA20 can be connected to a controller or printer.

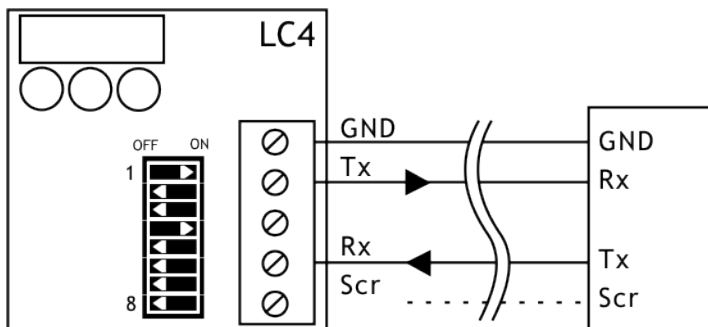

i The cable screen should **NOT** be connected to **both** the 'Scr' at the LC4 and the controller or printer. The cable screen should be connected to **either** the Scr terminal of the LC4 or a suitable screen connection on the controller or printer.

i Cable length for RS232 should be restricted to 25 metres.

RS422 and RS485 4 Wire

RS422 is a 4 wire connection used to connect to a single device or multi-dropped devices. i.e. Multiple LCA20s may be connected to a single controller.

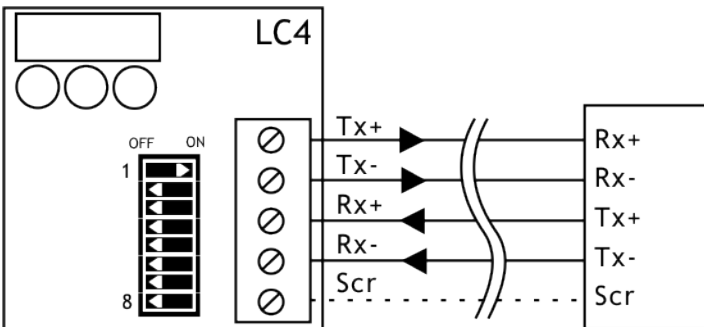

i The cable screen should **NOT** be connected to **both** the 'Scr' at the LC4 and the controller or printer. The cable screen should be connected to **either** the Scr terminal of the LC4 or a suitable screen connection on the controller or printer.

i For 4-wire RS485/RS422 use individually screened twisted multi-pair cable (Such as Farnell 121-8651) the pairs should be: Tx+ paired with Tx- , Rx+ paired with Rx-

Multi-drop Connections

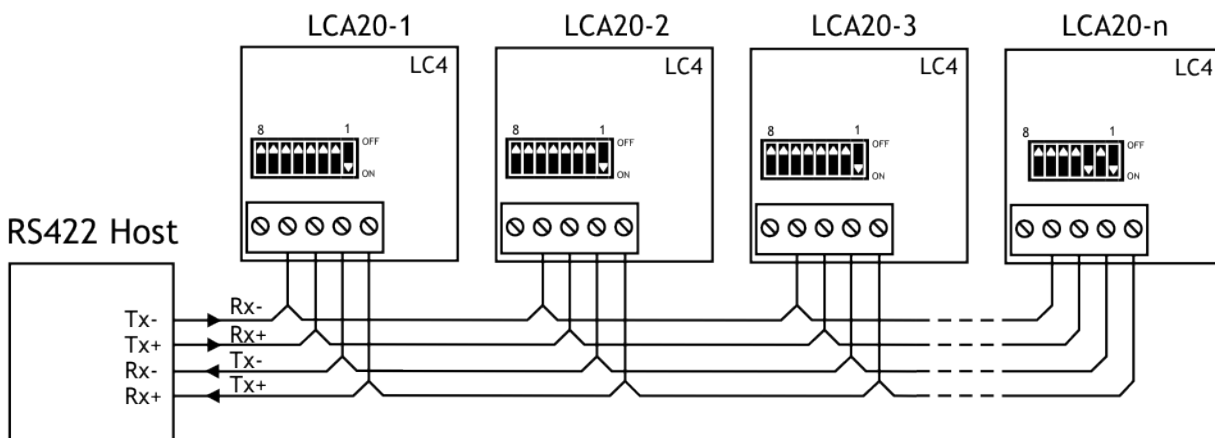

i The last LC4 module in the 'chain' has DIP switch position 3 set to On

RS485 2 Wire

RS485 is a 2 wire connection used to connect to a single device or multi-dropped devices. i.e. Multiple LCA20s may be connected to a single controller.

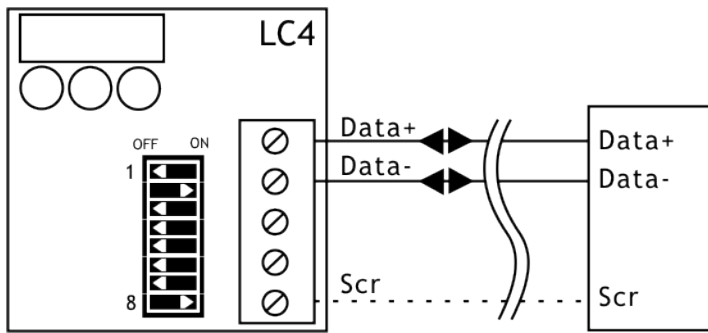

i The cable screen should **NOT** be connected to **both** the 'Scr' at the LC4 and the controller or printer. The cable screen should be connected to **either** the Scr terminal of the LC4 or a suitable screen connection on the controller or printer.

i Use single twisted pair cable for 2-wire RS485 (Such as Farnell 130-2298)

i Mantrabus1 communications protocol cannot be used on 2 wire RS485 bus.

Multi-drop Connections

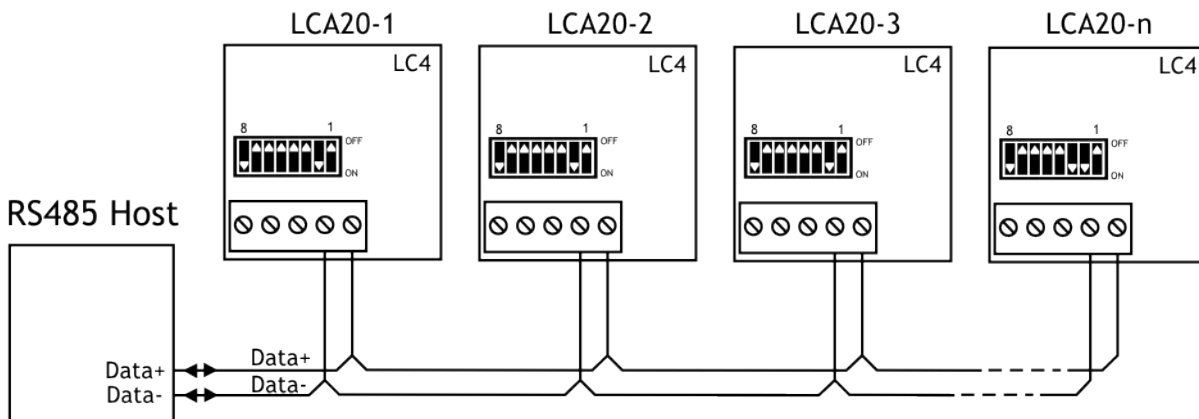

! The last LC4 module in the 'chain' has DIP switch position 3 set to On

Printer

A printer may be connected with an interface of type RS232, RS422 or RS485. See the above sections for connection information.

Programming Cable PGM1

For communicating with the module using the LCA Toolkit for configuration or firmware updates you have the option of using the PGM1 programming cable. This is a cheaper option than fitting an LC4 communications module and is intended for engineers to use in the field for configuration or for in-house configuration of modules that are to be installed with no communications module.

The programming cable plugs into J14 on the LCA20 module and plugs into the PC USB socket.

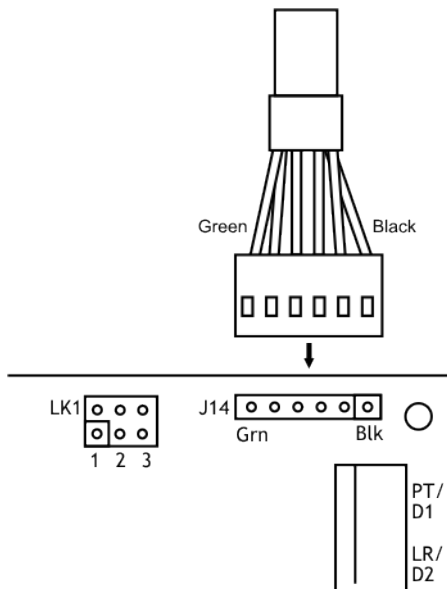

Please ensure correct orientation as marked by colour coding on LCA20 PCB

This will appear as a virtual RS232 port (COM port) on the PC.



When using the PGM1 cable the keypad on LP1 and LP2 displays are disabled.

The PGM1 cable is available from Mantracourt or can be purchased from Farnell or RS. Please see the following information:

Manufacturer: FTDI Chip. <http://ftdichip.com> Part number TTL-232R-5V

Supplier: RS 687-7770

Driver: <http://www.ftdichip.com/Drivers/VCP.htm>



A driver may need to be installed for the PGM1 cable to work correctly. This will create a virtual RS232 serial port (COM Port) which your own software or the LCA Toolkit will connect to.

Driver Settings

If you are using the communications to read or log data at high speed (This includes viewing the Trend Chart using the LCA20 Toolkit) you may find the desired speed is unachievable even with high baud rates. This could be due to the default settings of the **Latency Timer**. Open the **Control Panel** and launch the **Device Manager**.

Once **Device Manager** is open you need to locate the virtual COM port assigned to this interface. This will be listed under the **Ports (COM & LPT)** section of the hardware tree. You may need to unplug and re-attach the interface cable from the computer to identify which entry to use.

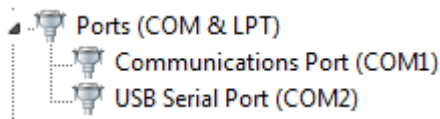

Double click the item to open the **Serial Port Properties** dialog window.

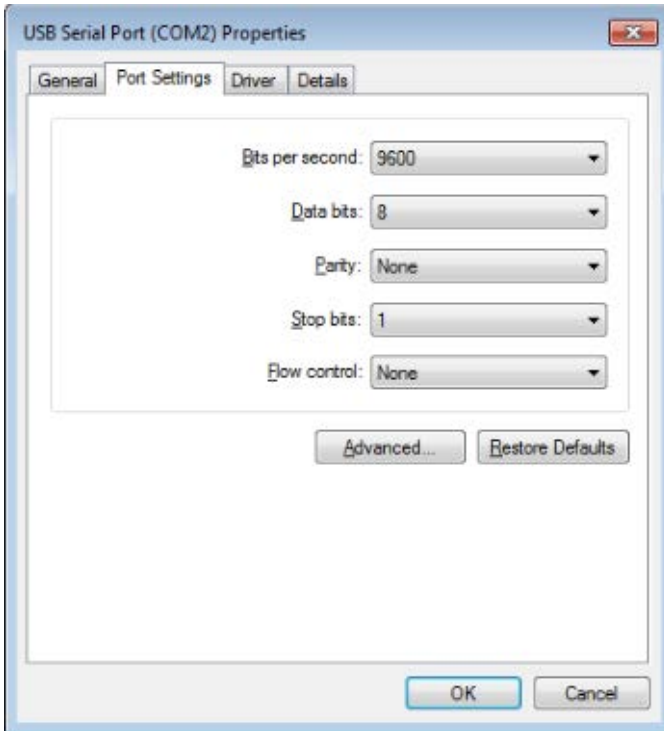

Click the **Advanced** button to display the **Advanced Settings**

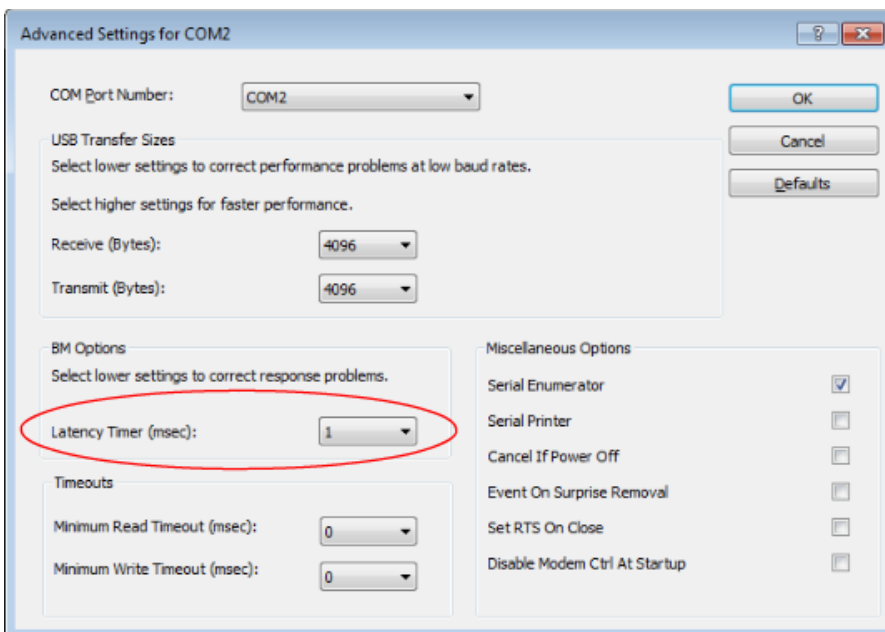

You need to ensure that the **Latency Timer** setting is set to **1**.

Serial / USB Convertors

If your computer does not have an RS232 or RS485 port built in you may opt to use a serial / USB convertor. These convertors plug into a USB port and create a virtual COM port so that the software has a serial port (RS232 or RS485) to connect to.

This section describes the connection of an Easysync ES-U-3001-M convertor.

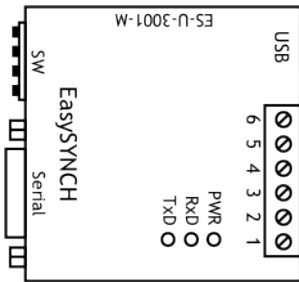

RS232

Set the SW DIP switches as follows  ON

The LCA20 is connected to the 9 way D plug as follows:

Pin Number	Pin Type	Description
2	In	RXD Receive Data
3	Out	TXD Transmit Data
5	Ground	GND

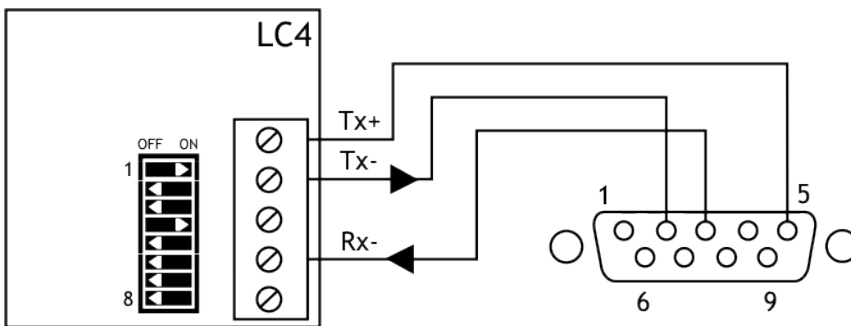

RS485

Set the SW DIP switches as  ON

The LCA20 can be connected to either the 9 way D plug or the 6 way screw terminals.

9 Way D Plug

Pin Number	Pin Type	Description
1	Out/In	Data- Transmit/receive negative polarity
2	Out/In	Data+ Transmit/receive positive polarity

6 Way Screw Terminals

Pin Number	Pin Type	Description
1	Out/In	Data- Transmit/receive negative polarity
2	Out/In	Data+ Transmit/receive positive polarity

The diagram below shows the connection to the 6 way screw terminals.

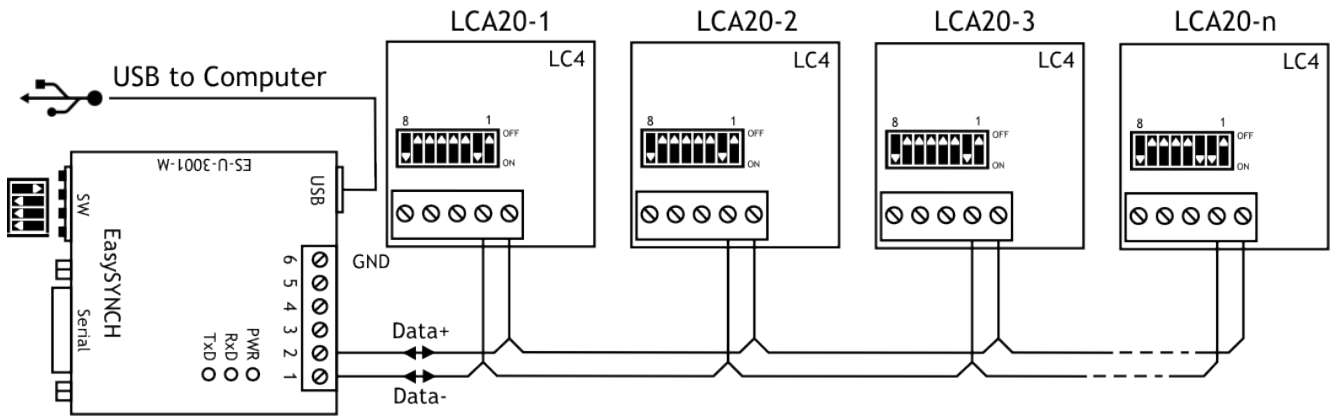

The last LC4 module in the 'chain' has DIP switch position 3 set to On

Driver Settings

If you are using the communications to read or log data at high speed (This includes viewing the Trend Chart using the LCA20 Toolkit) you may find the desired speed is unachievable even with high baud rates. This is due to the default settings of the **Latency Timer**. Changing this setting involves opening the **Device Manager** which will be dependent on your operating system.



See Also - [Installation](#) | [Connections](#) | [Programming Cable PGM1](#) | [Driver Settings](#) for more information.

LED Indicator

Status LED

The Green LED is used to indicate a number of functions.

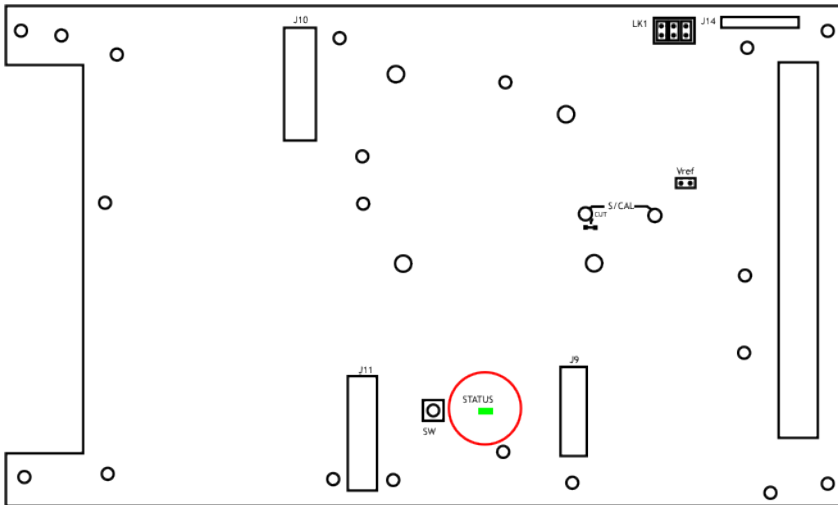

- Under normal healthy operating conditions the Green LED should be OFF flashing ON every second.
- If the LED is ON Flashing OFF every second then this indicates that an error condition exists and the reasons for this are as follows:
 - There is a Load cell integrity problem
 - The Shunt-calibration has been activated.
 - An Over-range or under-range condition exists.
 - The unit has had a 'watch-dog' reset. Cleared only by power cycling.
- The LED is permanently ON indicates the unit is either attempting to connect with the toolkit or already in communications with the Toolkit.
- Led Flashing approximately 10 times a second indicates the unit is in boot-loader mode either waiting to be re-flashed or because an incorrect or no Flash file exists in the processor.



See Also - [Using The LCA Toolkit Software | Save & Restore](#) for more information regarding updating the firmware.

Push Switch SW

This Switch is used to connect to the LCA Toolkit without the need to power cycle. See [Using The LCA Toolkit Software](#) section for operation. The LCA Toolkit software searches for modules connected to the serial bus and the modules can be power cycled to enable the software to detect them. Because there can be up to 250 modules connected the software can take a few seconds to ensure it has allowed enough time to detect all possible modules.

If only one module is on the serial bus then you can press and hold the push switch for 1 second and this tells the software not to wait to detect any more modules.

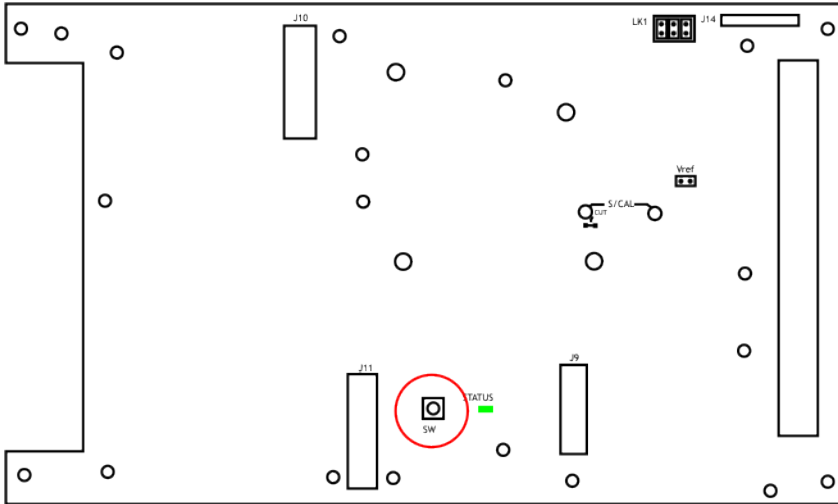

i The button needs to be held in for at least 1 second.

Appendix A - Calibration

Best practices

- Before calibrating the LCA20 it is advised that the device be powered on for 20 minutes to allow the electronics and load cells to stabilise.
- Set the Sensitivity and Decimal Point Parameters before calibrating
- For multi-point linearization / calibration we recommend the use of the toolkit as this simplifies the process.
- The best calibration is achieved by using the complete system using actual known weights.
- When using the multi-point linearization load the complete system in increments that allow a graph of non-linearity to be plotted. From this graph the best point can be determined for the calibration points.
- When multiple load cells are connected together in parallel ensure that they have equal mV/V outputs. Alternatively use an Active Junction module such as a JBA.

Table Calibration Method

If the load cell manufacturer's calibration certificate is available then it is possible to calculate gains and offsets that can be entered into the linearization table parameters. A simple way of achieving this is provided by the LCA Toolkit.

The LCA Toolkit's Calibration Advanced Tab is where you can view the actual linearization table parameters from either the Auto-Cal or Table calibration methods.

mV Source Calibration

If the load cell manufacturer's calibration certificate is available an alternative calibration method is to use the Automatic calibration method but instead of using the load cells and test weights a mV source can be connected as shown below can be used to calibrate the LCA20 instead

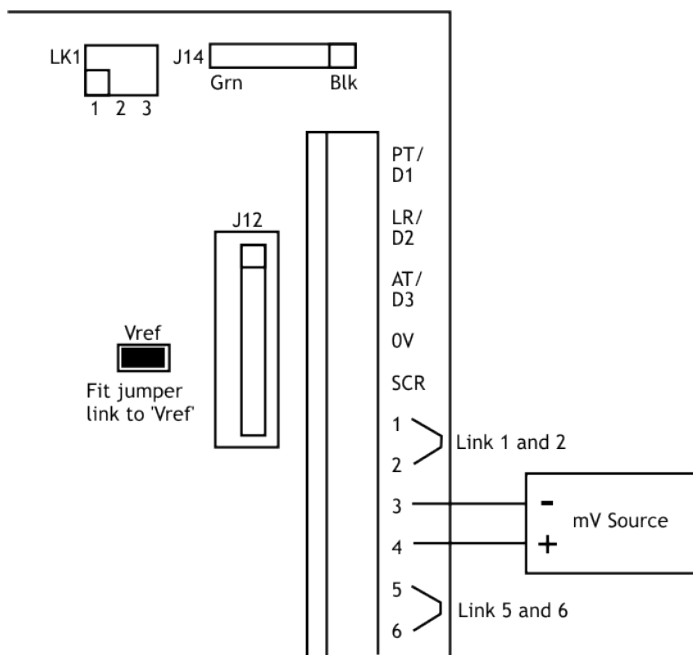

Fit the jumper link to the pins marked 'Vref'. Measure the Excitation voltage across 1 and 6 on the connector. Multiply by the mV/V values on the calibration certificate at the required calibration

load. Set the mV source to these values and perform the automatic calibration as described in the [Using the Wired Handheld Programmer](#) section of this manual.



Remember to Remove the jumper link when finished!

Vref

This Link when fitted biases the load cell input negative signal at 2.5V DC. This facilitates easy connection to certain type of barriers.

This feature is also useful for calibration where an mV signal is injected directly into the Signal inputs. See above mV Source Calibration

Shunt Calibration

The LCA20 is fitted with a 100k ohm resistor which, when commanded from a digital input or over the communications port, is placed across the Load Cell Negative Input and the Excitation Negative. This has the effect of changing the mV/V by a fixed amount in the positive direction.

The change in mV/V can be calculated as follows

$$\Delta mV/V = 1000R_g / (4R_s + 2R_g)$$

Where R_g is the Load Cell impedance

And R_s is the Shunt Calibration Resistor impedance.

Should the 100k resistor not provide enough mV/V change you can fit your own resistor to the board. To calculate a value for the Shunt Calibration resistor based on a required change in mV/V then the following formula can be used.

$$R_s = 0.25 (1000R_g / \Delta mV/V) - 2R_g$$



The Resistor should be a 0.5% 25ppm or better.

To remove the existing resistor from circuit cut the track as indicated below. Fit a leaded resistor to the position shown.

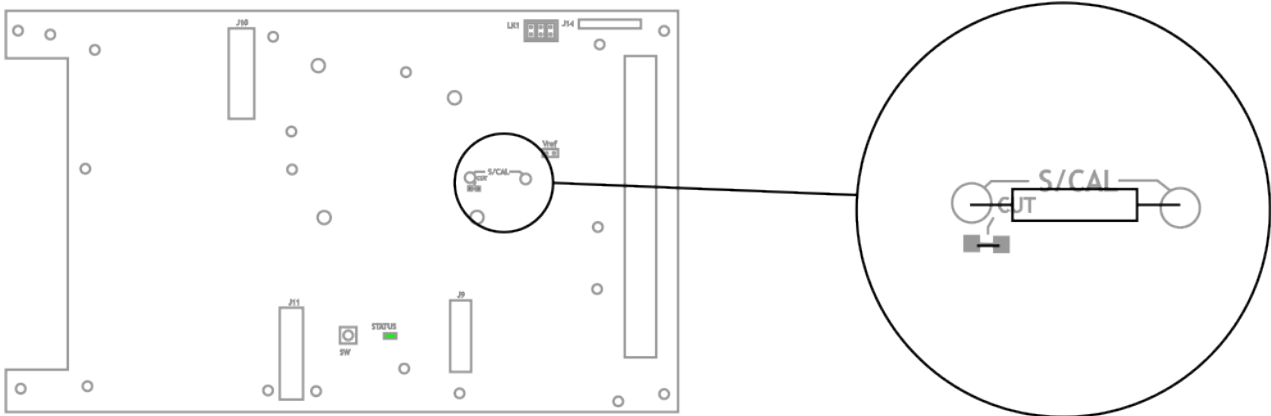



The Shunt Calibration is for indication and integrity purposes and should not be used to perform calibrations from.

Using Shunt Calibration

The Shunt Calibration facility allows a known value to be displayed thus allowing the integrity of the LCA20, load cell wiring and load cell to be checked. The load cell input should be constant before and during this Integrity check.

The Shunt Calibration can be switched on, off or toggled by a digital input. It can also be commanded on and off from the communications port. When Shunt Calibration is switched on the Status parameter will flag this and also flag that a Load Cell Integrity condition exists. The LCD display will indicate this by the PGM Arrow segment being on.

When the Shunt Calibration is commanded to switch on; but before the Shunt Calibration resistor is placed across the load cell; the current mV/V value is recorded in a Pre Shunt Calibration Value parameter. This is used when calculating the Shunt Calibration Scaling factor parameter see following.

$$\text{Shunt Calibration Scaling Parameter} = \left(\frac{\text{Required known value}}{\text{Post Shunt Calibration mV/V} - \text{Pre Shunt Calibration Value parameter}} \right) * 10$$

Note: When Shunt Calibration is switched on the LCA20 values such as Gross, Net, Peak, Valley ETC are also affected. Consequently the Analogue out and relays are also affected.

Appendix B - Measurement

Overview

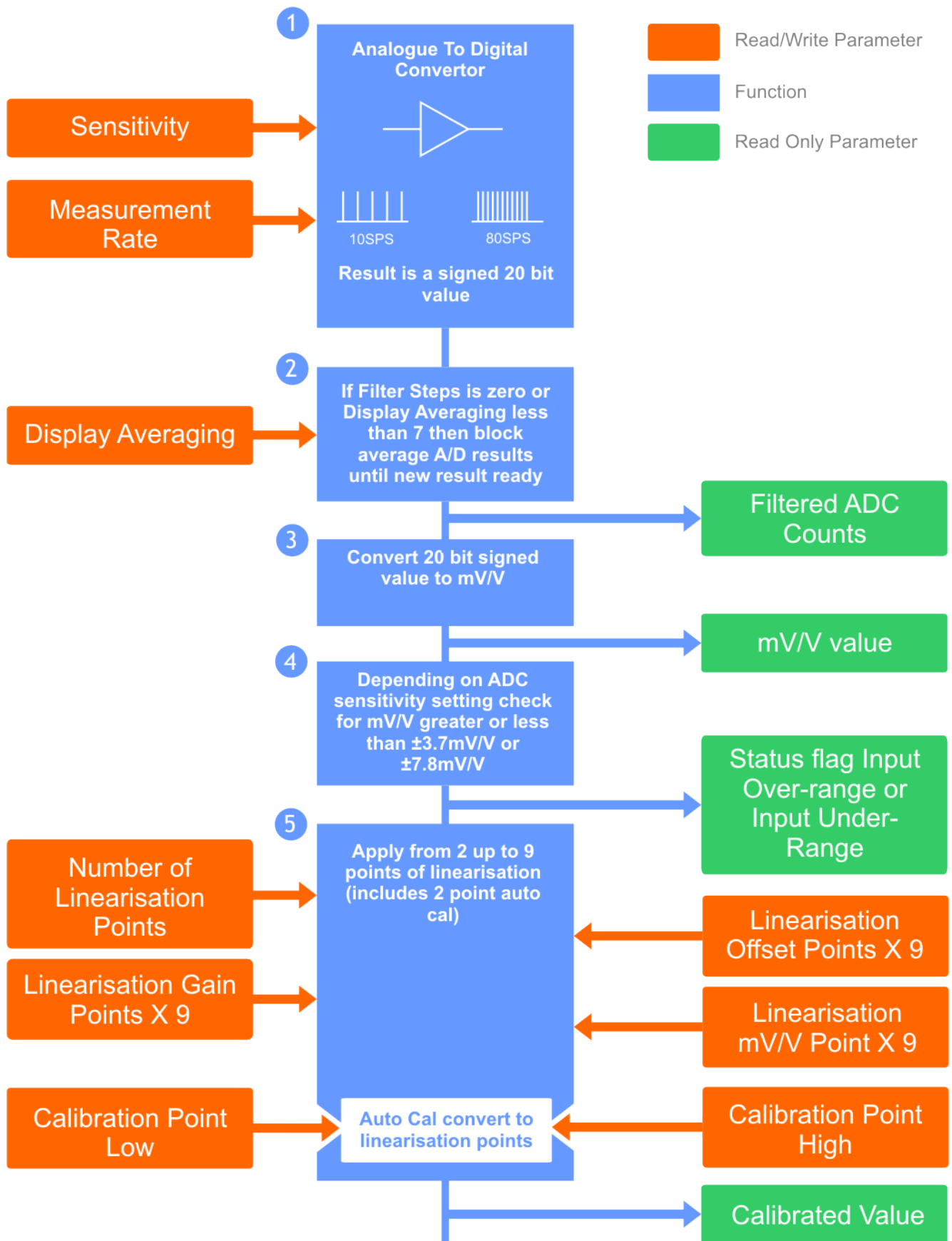

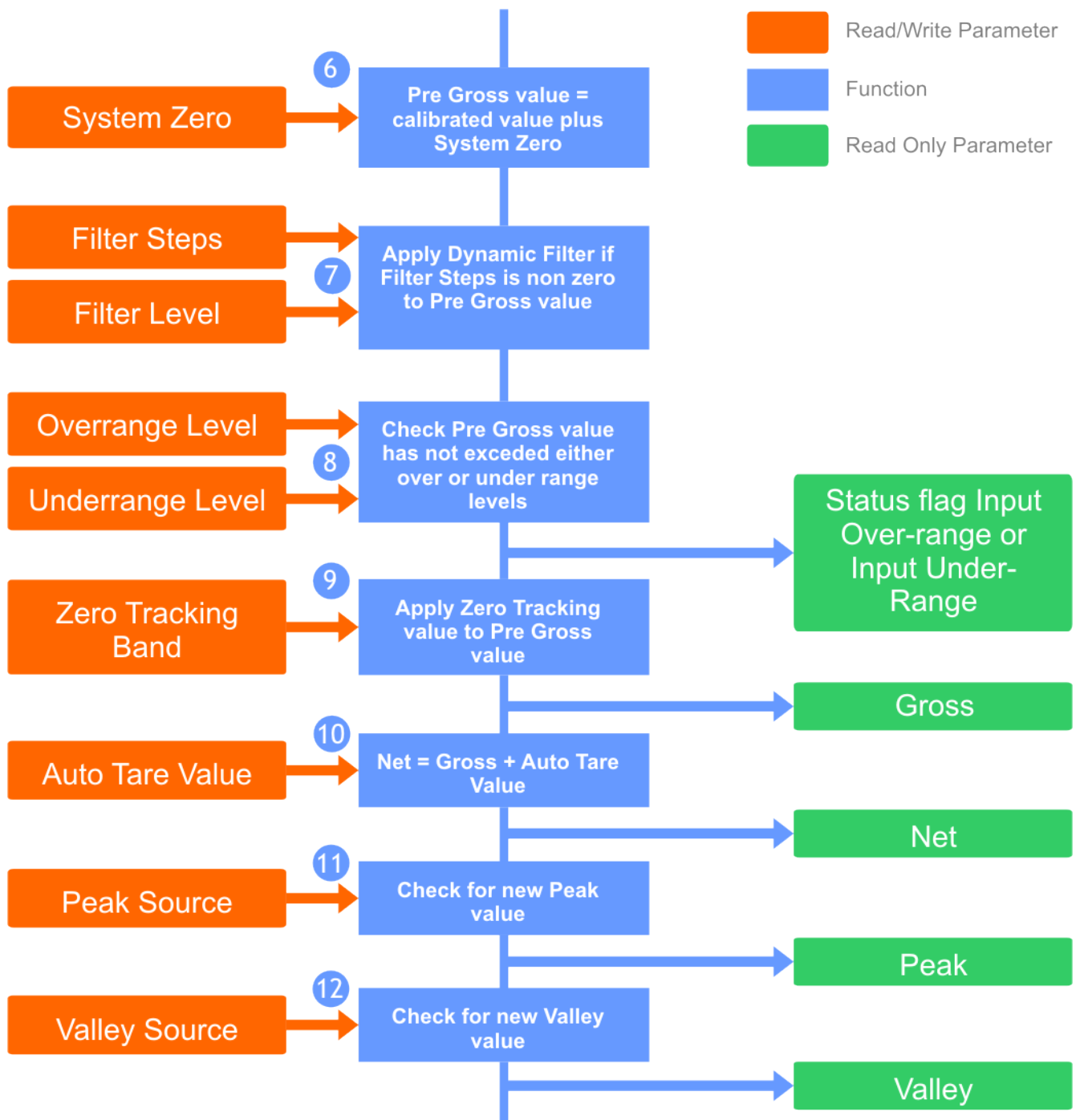

1. The measurement process starts by converting the load cell analogue values to digital values. The Analogue to Digital Converter (ADC) has a bipolar input allowing for load cells to be used in both tension and compression. The ADC measures the 5V excitation voltage using the sense inputs and through an amplifier the output of the load cells from these two measurements the mV/V output from the load cells is calculated. This amplifier has two gain settings allowing for two ranges, $\pm 3.7\text{mV/V}$ and $\pm 7.8\text{mV/V}$. These gains setting are selected by the Sensitivity parameter. The ADC can also take measurements at two different rates, 10 samples per second (sps) and 80sps, selected by the Rate parameter. The output from the ADC is a signed 20bit result in ADC counts terms.

2. When a new ADC result is available; which is determined by the Rate parameter; the process is checked to see if block averaging is required. This is determined by the value set in the Display Averaging parameter and the digital low pass filter parameter Filter Steps. The block averaging is bypassed if Display Averaging parameter is set to 7 or the Filter Steps parameter is non zero. Block averaging simply adds a number of results together then divide the result by the number of results added (known as the mean). For Display Averaging values of 0-6 the number of result to average is calculated as...

2 to the power of (Display Average + 2)

Once a new block average value is ready the Filtered ADC Counts value is updated and the process continues.

3. The Filtered ADC Counts Value is then converted using the factory calibration to a mV/V value to within 0.05% accuracy.
4. This mV/V value is then tested to see if in fact the input has been over or under ranged and if so an internal input over or under range flag is set that is checked later in the process (see 8).
5. The current mV/V value is then converted into the user desired engineering units using the 9 point linearization programme. This programme searches the mV/V levels for each point to find what Gain and Offset values to apply. The number of points to search through is set by the Number of Calibration Points parameter. If the current mV/V is above or below the last or first mV/V table level then the gain and offset values to be used are extrapolated from the last or first two points.
When the 2 point Auto-Calibration routine is used the same principle applies. The auto-cal calculates the values for the first two points in the table using the mV/V values captured for Calibration Low and Calibration High parameters.
The output from this process is termed the Calibrated Value.
6. The **System Zero** parameter is then added to the Calibrated value to give an intermediate internal value known as Pre-Gross Value.
7. If block average has not been selected as determined in (2) above and the Filter Steps parameter is non-zero then the Low Pass Filter algorithm is implemented. This is covered in [Appendix B - Measurement | Filters](#). The Pre-Gross value is updated with the result of the Low Pass Filter.
8. The Pre Gross Value is checked against the Over and Under Range parameters and if exceeded or if the internal input over or under range flag is set then the Status and Flag Parameter is updated accordingly. The Flag parameter being a non-volatile latched flag requiring user intervention using the communications port to be reset.
The Gross and Net values are set to over or under range values also. This ensures that the display, relays, analogue output and communication ports all detect and recognise this error condition.

9. Pre Gross Value is now adjusted with the Zero Tracking value. Zero Tracking is enabled when the Zero Tracking Band parameter is non-zero.
10. Net is calculated by adding the Auto-Tare parameter to the Gross.
11. The Peak value is checked against the source selected by the Peak Selection parameter which could select either Gross or Net values.
12. The Valley value is checked against the source selected by the Valley Selection parameter which could select either Gross or Net values.

Zero Tracking

Zero tracking is applied to the Gross value.

A Tracking Band parameter sets a band about the Pre Gross absolute zero value. If a Tracking Band parameter has a value of 10.0 then the band is calculated as between + 10.0 and -10.0. If the Pre Gross value is in between these two calculated values for more than 1 second then the value of Pre Gross is stored as the new zero tracking value.

This Zero Tracking value is then subtracted from the Pre Gross value to give a Gross value of zero. Zero Tracking can be disabled by setting the Tracking Band Parameter to zero. The Zero tracking value is volatile therefore reset to zero on power up.

System Zero

System Zero is used to remove permanent values from an installed system such as the weight of a vessel or weighing platform to give a zero Gross value.

The **System Zero** parameter is then added to the Calibrated value to give an intermediate internal value known as Pre-Gross Value.

Auto Tare

The Auto Tare facility enables the generation of the Net value. The Net Value is calculated as the Gross value added to the value set in the Auto Tare parameter. An update of the Auto Tare value can be commanded from a digital input or from the communications port. Additionally an Auto Tare value can be entered into this parameter from the keypad or again using the communication port. The Auto Tare parameter is non-volatile and is therefore saved through power fail.

Filters

Overview

The least significant digits of the display or values over the communications port may change excessively in certain applications due to vibration or 'noise' on the input. Filtering can be applied to smooth the display by two methods.

The simple block average filter uses averaging and therefore generates new values at the **Measurement Rate** which is slower than the **A/D Measurement Rate**.

The dynamic digital low pass filter uses software to generate new values at the **A/D Measurement Rate**.

Simple Block Averaging

Block averaging delays the generation of a new output value until a number of new values generated at the **A/D Measurement Rate** have been averaged. This provides a very steady display or output but at the expense of a slow update rate. The range of choices of the final update rate is dependent on the selected **A/D Measurement Rate**.

A/D Measurement Rate is set to 10 samples per second

10 samples per second
2.5 samples per second
1.25 samples per second
1.6 seconds per sample
3.2 seconds per sample
6.4 seconds per sample
12.8 seconds per sample
25.6 seconds per sample

A/D Measurement Rate is set to 80 samples per second

80 samples per second
20 samples per second
10 samples per second
5 samples per second
2.5 samples per second
1.25 samples per second
1.6 seconds per sample
3.2 seconds per sample

Dynamic Digital Low Pass Filter

The dynamic filter is a digital low pass filter implemented in software which behaves like an electronic 'RC' circuit. It has two user settings, a **Filter Level** set in the calibrated engineering units and the maximum number of steps, **Filter Steps** 1 to 255. To bypass the dynamic filter set **Filter Steps** to 0.

Instead of outputting every new value, a fraction of the *difference* between the new input value and the current filtered value is added to the current filtered value to produce the filtering action.

If this difference is less than the value set in **Filter Level** then the fractional amount added each time is decremented until it reaches the minimum level set by **Filter Steps** i.e. **Filter Steps** is the *limit* of the divisor.

Example: if **Filter Steps** = 4, initially the whole difference between the new value and the current filtered value is added to the current filtered value. The next value displayed is the result of adding one half of the difference. The following update adds one third while subsequent updates continue to add one quarter of the difference, the limit of the divisor having been reached i.e. $1/\text{Filter Steps} = 1/4$.

If **Filter Steps** were increased to 10, the process would loop for ten times then continue to add just 10% of the difference resulting in a longer settling time but deeper filtering effect.

If a rapid or step change in the input causes the difference between the new input value and the current filtered value to exceed the amount set in **Filter Level**, the filter acquires the new value immediately by resetting the divisor to 1. The filtering process repeats as above on subsequent updates by adding one half of the difference, one third, one quarter etc. until $1/\text{Filter Steps}$ is reached. This allows the Filter to respond rapidly to fast moving input signals but still retain its smoothing characteristic as the input settles.

When a step change occurs which does not exceed **Filter Level**, the new filtered value is calculated as follows:

$$\text{New Filter Output Value} = \text{Current Filter Output Value} + \left(\frac{(\text{Input Value} - \text{Current Filter Output Value})}{\text{Filter Steps}} \right)$$

Note: To retain the filtering effect but defeat the step change response set **Filter Steps** appropriately and **Filter Level** to 0.

The time taken to reach 63% of a step change input (which is less than **Filter Level**) depends on the rate at which values are passed to the dynamic filter, set in **A/D Measurement Rate** (10 or 80 samples per second (SPS)), multiplied by **Filter Steps**.

The table below gives an indication of the response to a step input which is less than **Filter Level**.

% of Final Value	Time To settle
63%	Measurement Period * Filter Steps
99%	Measurement Period * Filter Steps * 5
99.9%	Measurement Period * Filter Steps * 7

For example, if **A/D Measurement Rate** is set to 80 samples per second (12.5ms period) and **Filter Steps** is set to 30 then the time taken to reach a percentage of the step change value is as follows:

% Of Final Value	Time To settle
63%	0.0125 x 30 = 0.375 seconds
99%	0.0125 x 30 x 5 = 1.875 seconds
99.9%	0.0125 x 30 x 7 = 2.625 seconds

Frequency Response:

For a sinusoidal input the -3dB point, i.e. the frequency where the output is 0.71 of the input is given by:

$$\text{Frequency} = \left(\left(\frac{\text{SampleRate(SPS)}}{\text{Filter Steps}} \right) \times \frac{1}{6.3} \right)$$

To calculate the number of steps for a -3dB frequency point use:

$$\text{Filter Steps} = \left(\frac{\text{SampleRate(SPS)}}{(\text{Frequency} \times 6.3)} \right)$$

Peak and Valley Values

The LCA20 incorporates a Peak/Valley function which continuously monitors the Gross or Net value, selected by the Peak and Valley Selection Parameter, and stores the minimum (valley) and maximum (peak) values. These values are volatile and reset on power up.

Peak and Valley values can be used as the default display value, analogue output and relay source values. That is to say, the display can be set to show Peak value, Relay 1 source value could be Peak, Relay 2 could be Valley and the analogue output source value also set for Peak.

Peak and Valley values can also be selected to view by using the digital inputs. For example Digital input 1 could be used to display Gross value, Digital input 2 to display Peak value and digital input 3 to display Valley value.

Peak and Valley values can be reset from a digital input or using the communications port.

Snap Command

Executing the **Snap** command by either the serial communications or one of the digital inputs configured to **Do Snap** will store a 'snapshot' of the **Snap Source** value at that instant in time.

The **Snap** value can be recalled later by three means:

- Set the display source to **Snap** to view the stored value on the optional display.
- Configure one of the digital inputs to **Display Snap Value** and apply a closed contact to view the stored value on the optional display.
- Via the serial communications interface by reading the **Snap** parameter.



By setting Digital Input 1 to Do Snap, Digital Input 2 to Display Snap Value and Digital Input 3 to Display Gross Value the snap value can be captured by a contact closure on Digital Input 1, displayed via Digital Input 2 and the display reset by Digital Input 3 to show live Gross again.



The SNAP command also enables readings from multiple LCA20s in an installation to be synchronised by issuing the Snap command (either via the communications bus or a physical input connected to the suitably configured digital inputs) to each unit simultaneously and then polling each device reading its Snap value.

Appendix C - Relays

Overview

The optional Relay output module, RL1, provides two output control signals which can be used for switching functions such as ON/OFF control and alarm indications. The relays are activated by the values programmed for the Set Points.

Module Functions

The LCA20 can be programmed so that the relay output module reacts to all or any of the following functions:

- Source for relay such as Gross, Net, Peak, Valley and Snap
- Setpoints
- Inflight compensation
- Hysteresis
- Relay inversion
- Relay latching

The two relays provide Single Pole Change-Over (SPCO) contacts and are rated at 240VAC at 5A. The connections are shown below.

LR1 Relay Module

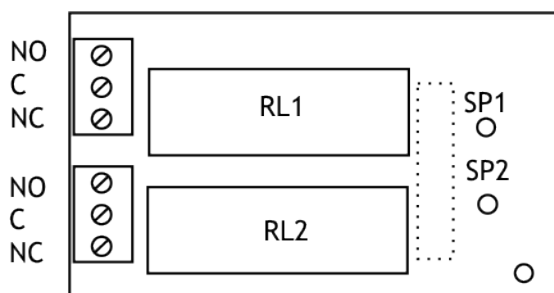

Source

For LCA20 mode the source value for each relay can be selected from the following values; Net, Gross, Peak, Valley and Snap.

Setpoints

Setpoints are used to produce relay signals at any required value so that the operation of the monitored process can be maintained to pre-set levels. Any excursion beyond the **Setpoint(s)** will normally activate the relay or relays to provide an alarm or initiate control as required.

Two relays can be programmed to suit different applications. The actions of either or both relays can be inverted if required.

For normal operation the relay is energised until the input reaches the **Setpoint** level. In this condition, when the input value is less than the **Setpoint**, the setpoint LED is on and the output relay is energised producing a closed circuit on a normally open contact. When the **Setpoint** value is reached, the setpoint LED turns off and the relay is de-energised producing an open circuit on a normally open contact.

For an **Inverted** operation the reverse operations apply.

Normal and inverted action is determined by the direction of the input value as it changes.

A High-High operation allows for a rising input value to operate on two relays to define an acceptable quantity, weight or band of operation.

A Low-Low operation operates on a falling value.

A High-Low operation will operate on a rising or falling value, setting a 'band' by one relay operating normally and the other being inverted.

Inflights

The setting of an **Inflight** value causes the relays to automatically adjust to control the flow of the material being weighed.

For example, if a relay is used to control a flow, a certain amount of product will be '**Inflight**' between the supply point and receiving point causing a positive error when the required weight is reached. The **Inflight** compensation value is adjusted by the user to reduce the **Setpoint** value to prematurely stop the flow, allowing the **Inflight** amount to make up the required total set by the associated **Setpoint**.

Hysteresis

When **Hysteresis** is applied to relays with normal output action, the input is allowed to rise to the **Setpoint** value and the relay is then turned off. The relay is held off until the input value has dropped to the **Setpoint** minus the **Hysteresis** value.

For inverted action the input drops to the **Setpoint** and the relay goes off and comes on again when the input rises to the **Setpoint** plus the **Hysteresis** value.

For LCA15 mode **Hysteresis** will be applied to both **Setpoint** values. It is effective for both normal and **Inverted** action.

Inversion

A normal, non-inverted relay is defined as being in the energised state when the source value is below the resultant setpoint.

An inverted relay is defined as being in the energised state when the source value is above the resultant setpoint.

Note the LED's fitted to the LR1 denote whether a relay is energised or de-energised. The LED is ON for an energised relay.

Latching

The latching facility allows the relay module output to be held until reset externally via the digital input or via the communications port. Latching is applied to the 'off' status of the relay.

Latched relays are reset by operating a closing contact connected between 'LR' terminal and '0' volts, on the field terminals (this assumes that Digital Input 2 is set to its default function 'LR')



See Also - [Appendix E - Digital Inputs](#) for more information.

Appendix D - Analogue Output

Overview

Two analogue outputs are available offering a DC current range (4 to 20mA) and a DC voltage range (0 to 10V).

They are fully scalable, optically isolated and both generated from a single selected variable (see source below)

Both outputs are pre-calibrated to an accuracy of 0.15% FR and have a resolution of approximately 13 bits or 1 part in 8000.



WARNING:

Maximum load on voltage modules is 10mA

Maximum drive voltage available for the current range is 20V

Source

The value the selected analogue output, 4-20mA or 0-10V, calculates its output from can be sourced from Net, Gross, Peak, Valley or Snap values.

Scaling

Output scaling factors are set by the user and determine the display range over which the analogue module operates.

Output Low - This sets the displayed value at the analogue outputs minimum i.e. 4mA or 0V.

Output High - This sets the displayed value at analogue outputs maximum output i.e. 20mA or 10V

If the display is outside the range defined by **Output Low** and **Output High** scale factors the analogue output will remain constant at its minimum or maximum output value.

So for example, if the 4-20mA output is selected and **Output Low** scale factor is set to 00.00 whilst the **Output High** scale factor is set to 100.00 then if the source value is at 00.00 or less the 4-20mA output will be at 4mA level and consequently if the source value is 100.00 or greater the 4-20mA output would be at 20mA.

Inversion of the analogue output can be set by the Output Action parameter or transposing **Output Low** and **Output High** scale factors.

Calculating the Scale Factors

Example: Assume a 4-20mA output module is required to provide an output of 4mA for 1000Kg and 20mA for 6500Kg.

Set **Output Low** to 1000 and Output High to 6500

It will be necessary to determine **Output Low** and **Output High** scale factors by graphical or mathematical means if the known source values do not coincide with the minimum and/or maximum analogue output.

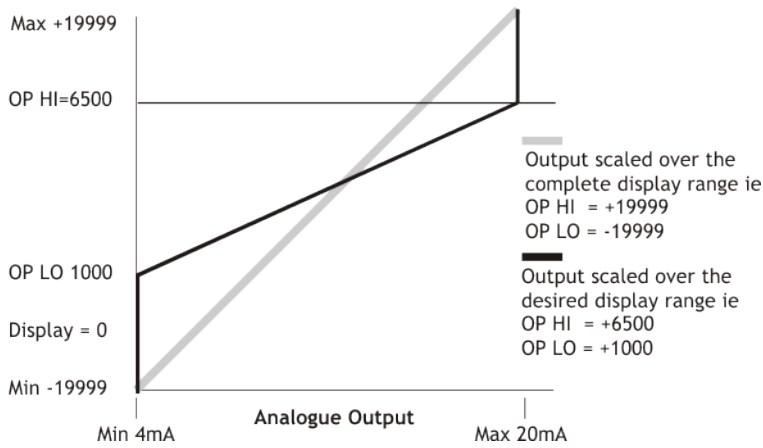

Method of Calculating Output Low & Output High from known output values

$$\text{Output Low} = \text{Low Display} - \left(\frac{\text{Display Span} * (\text{Low Output} - \text{Min Output})}{(\text{High Output} - \text{Low Output})} \right)$$

$$\text{Output High} = \text{High Display} + \left(\frac{\text{Display Span} * (\text{Max Output} - \text{High Output})}{(\text{High Output} - \text{Low Output})} \right)$$

Where:

Low Output	Required analogue output at low display value
High Output	Required analogue output at high display value
Min Output	Lowest value of analogue output (4mA or 0V)
Max Output	Highest value of analogue output (20mA or 10V)
Display Span	Required High display value minus required Low display value.

Example

To scale the output from 6mA at a display value of 400 to 18mA at a display value of 1100:

$$\text{Display Span} = (1100 - 400) = 700$$

$$\text{Output Low} = 400 - \left(\frac{700 * (6 - 4)}{(18 - 6)} \right)$$

$$\text{Output Low} = 400 - \left(\frac{1400}{12} \right) = (400 - 116.66)$$

$$\underline{\text{Output Low} = 283.33}$$

$$\text{Output High} = 1100 + \left(\frac{700 * (20 - 18)}{(18 - 6)} \right)$$

$$\text{Output High} = 1100 + \left(\frac{1400}{12} \right) = (1100 + 116.66)$$

$$\underline{\text{Output High} = 1216.66}$$

Note 1: The output can be inverted by setting Output Low more positive than Output High.

Note 2: If **Output Low** or **Output High** is greater than ± 19999 then divide both **Output Low** and **Output High** by 10, this will give less resolution.

User Adjustment

The LCA20 has no Potentiometers for trimming the 4-20mA and 0-10V outputs as did its predecessor. Instead the output can be 'trimmed' digitally using parameters that can adjust both the 4-20mA and the 0-10V outputs for gain and offset. This is useful for when the input of the device that the LCA20 is connected to is not accurately calibrated itself or, in the case of the voltage output, to compensate for small voltage drops in the cabling.

As an example, setting the 4-20mA and 0-10V Gain parameters to 0.5 re-scales the analogue outputs to 4-12mA and 0-5V respectively.

An offset can be introduced by entering a value for 4-20mA and 0-10V Offset parameters with one digit nominally representing 2.03uA and 1.254mV respectively.

The factory calibration can be re-instated by resetting the offsets to 0 and the gains to 1.

Output Override

The analogue output can be overridden and set to a fixed level by entering a value for **Analogue Output Force Counts** via serial communications enabling the LCA20 to act as a manual process controller via a suitable interface or isolated current or voltage supply for low power sensors with up to 10mA being available from the 0-10V output.

Analogue Output Force Count ranges from approximately 1160 to 9055 for the 4-20mA range and 1180 to 9150 for the 0-10V range with one digit representing 2.03uA and 1.254mV respectively.

Appendix E - Digital Inputs

Overview

The LCA20 has 3 Digital inputs. These inputs are volt free which require either a contact closure or open collector type output which connects the particular input to the terminal marked '0V'. The input has an internal 1000 Ohm resistor pulling the input to +5Vdc. The input requires to be closed for a minimum of 300ms due to the de-bounce circuitry. Note that these inputs are not isolated from the load cell input.



WARNING - Do not apply voltages to the digital inputs.

The three Digital inputs can be individually configured to provide the following functionality.

Digital Input selection table

<i>Description</i>	<i>Notes</i>
Perform Tare	Perform a tare action.
Latch Relay Reset	Reset any latched relays.
Do Print	If the Communications Protocol is set for Printer output then an ASCII string will be sent from the serial port.
Display Default display	Switch the display to the original display source value.
Display Gross value	Switch the display to Gross value.
Display Net value	Switch the display to Net value.
Display Peak value	Switch the display to Peak value.
Display Valley value	Switch the display to Valley value.
Display Snap value	Switch the display to Snap value.
Peak & Valley Reset	Reset the peak and valley capture values.
Shunt-Cal On	Turn Shunt calibration on. The Shunt Calibration Value available over the communications bus and optional display will show 100 if integrity of load cell and wiring is OK and the Shunt Calibration value has been calibrated. See Using the LCA Toolkit Software Calibration Shunt Calibration section of the manual for more information.
Shunt-Cal Off	Turn off shunt calibration.
Shunt-Cal Toggle on/off	Toggle between shunt calibration on and off.
Do Snap	Store the current value of the snap source to the snap value.

Appendix F - Security Locking

By default the LCA20 arrives from the factory unlocked in terms of requiring changes to hardware to gain access to certain functionality.

Menu Passwords

Access to menu sections using the wired handheld programmer/display is controlled by passwords. The user is asked for a password and depending on the password entered gains access to the appropriate section and all sections beneath.

These passwords are fixed as follows:

Level 1 Password	1111	Operator
Level 2 Password	2111	Engineer
Level 3 Password	3111	Advanced Calibration / Configure

Handheld/Display Calibration Lock

There is also a hardware link on the main board that if removed will hide the CALL, CALH, ADCL, ADCH and SENS parameters from the handheld menu and thus prevent calibration.

LK1 Jumper Link On	Calibration Visible
LK1 Jumper Link Off	Calibration Hidden

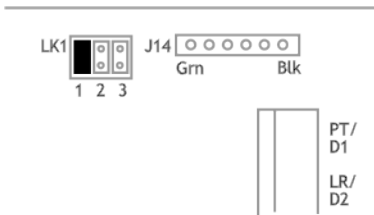

LCA Toolkit Lock

LK2 on the main board controls access to the Lock page in the Toolkit. When the jumper link is fitted all pages are visible including this Lock Page.

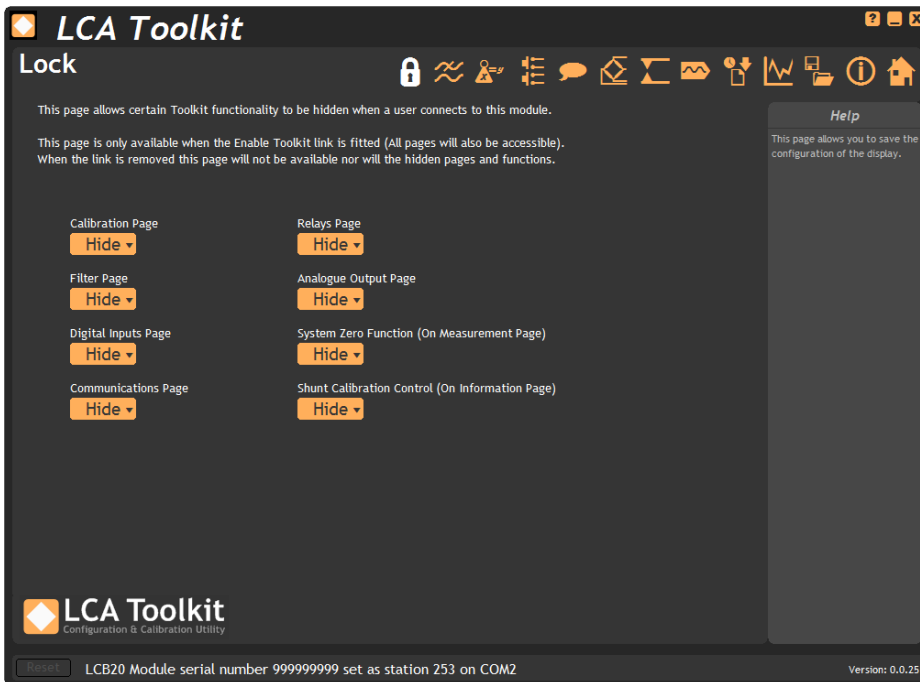

Certain pages and functionality can be hidden or disabled using this page. Once the LK2 jumper link is removed and the module is connected to the LCA Toolkit this page and all other selected pages and functions will be hidden.

LK2 Jumper Link On
LK2 Jumper Link Off

All Pages Visible
Lock Page & Selected Pages Hidden

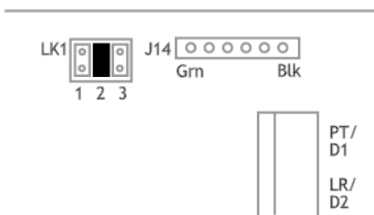

Appendix G - Manual Connect

If you cannot get physical access to the LCA20, to power cycle or to push the button, you can connect manually by clicking the 'Manual Connect' text on the Home page.

To connect manually you will need to know the baud rate configured in the module along with the station number. Also to manually connect the module must have been configured for Mantrabus2 protocol.

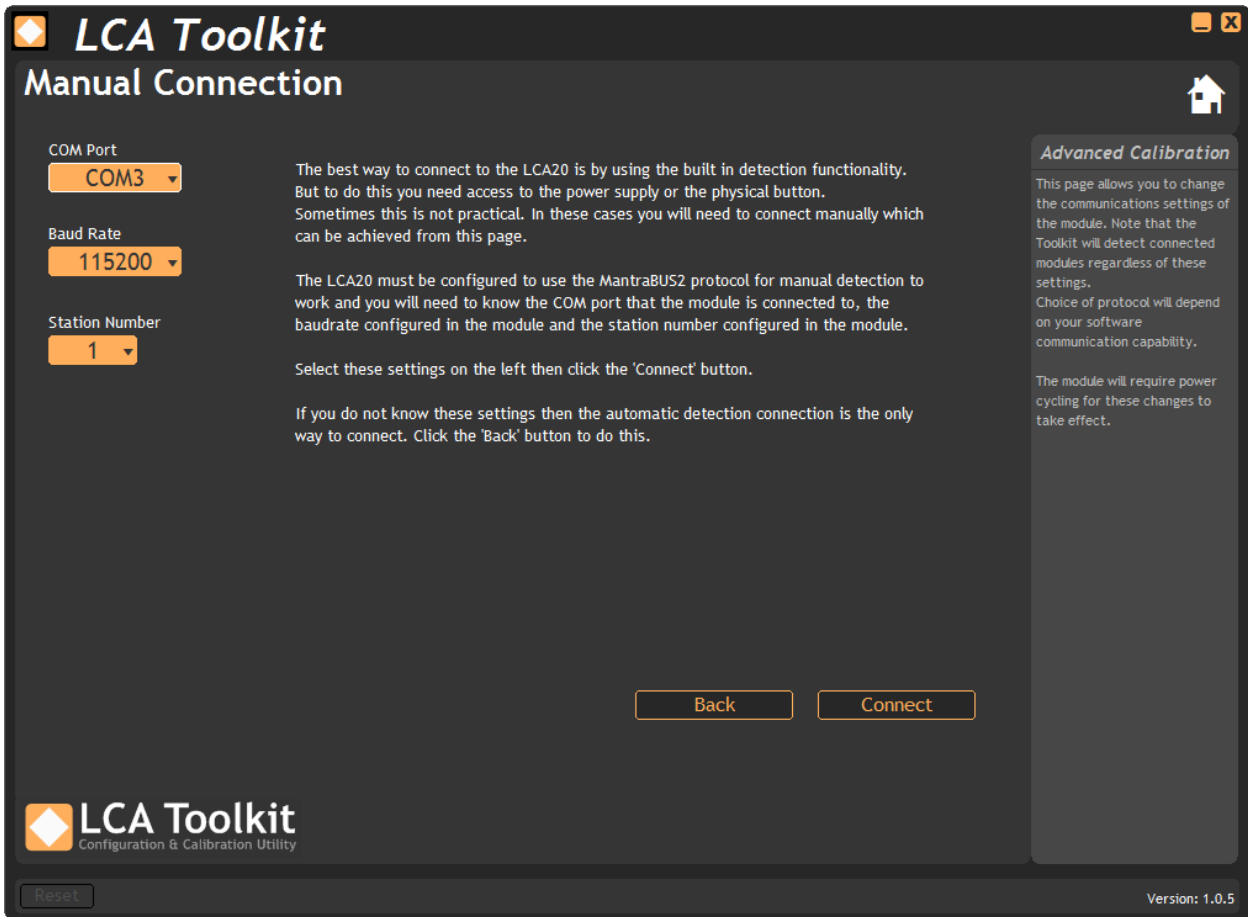

COM Port - Select the COM port that the LCA20 is connected to. The drop down list will be populated with all detected Com ports.

Baud Rate - Select the baud rate that the module is configured to use.

Station Number - Select the station number the module is configured as.

Back Button - Go back to the Home page.

Connect Button - Attempt to connect to the specified LCA20 module. If successful the [Information page](#) will be displayed.

Specifications

Electronics

Loadcell Input

<i>Physical Parameter</i>	<i>Minimum</i>	<i>Typical</i>	<i>Maximum</i>	<i>Units</i>
Strain Gauge Excitation System		6 Wire		
Strain Gauge Excitation Voltage	4.75	5.0	5.25	V
Strain Gauge Drive Capability			35	ohms
Strain Gauge Sensitivity Range 1			±3.7	mV/V
Strain Gauge Sensitivity Range 2			±7.8	mV/V
Offset Stability @ 2.5mv/V FS		±2		ppm/°C
Gain Stability		±4		ppm/°C
Offset Stability With Time		±3		ppm FR
Gain Stability With Time 1 st Year		±6		ppm FR
Integral Non Linearity Before Linearisation		±10		ppm
Internal Resolution		1:1000,000/20		Resolution/Bits
10hz Noise Free Resolution		1:180,000/17.5		Resolution/Bits
80hz Noise Free Resolution		1:130,000/17		Resolution/Bits

Analogue Output

<i>Physical Parameter</i>	<i>Minimum</i>	<i>Typical</i>	<i>Maximum</i>	<i>Units</i>
Current Output	4		20	mA
Current Output Drive Capability			1	K Ohm
Voltage Output	0		10	V
Voltage Output Drive Capability	5			K Ohm
Phase Delay - Sine Wave		55		ms
3db Down Point		8.5		Hz
Phase Delay - Step Change		26		ms
Rise/Fall Time (10% To 90% FR)		40		ms
Rise/Fall Time (1% To 99% FR)		85		ms
Zero Stability		0.005	0.01	%FS/°C
Gain Stability		0.005	0.01	%FS/°C
Resolution		1:8000/13		Resolution/Bits
Isolation	±130V RMS or DC to any other port			

Above specification is based on a Measurement Rate of 80 samples per second and no averaging or filtering.

Power Supply (LS1, LS3)

<i>Physical Parameter</i>	<i>Minimum</i>	<i>Typical</i>	<i>Maximum</i>	<i>Units</i>
LS1 Supply Voltage (230V AC)	210		260	V AC
LS1 Supply Voltage (110V AC)	97		120	V AC
LS1 Power			10	W
LS3 Supply Voltage (DC) Isolated	9		32	V DC
LS3 Power			10	W

Relays (LR1)

<i>Physical Parameter</i>	<i>Minimum</i>	<i>Typical</i>	<i>Maximum</i>	<i>Units</i>
LR1 Contact Type		2 X SPCO		
LR1 Contact Rating		240V AC @ 5A		

Communications (LC4)

<i>Physical Parameter</i>	<i>Minimum</i>	<i>Typical</i>	<i>Maximum</i>	<i>Units</i>
Data Transmission Rate	2400		115200	bps
Isolation	±130V RMS or DC to any other port			
Supported Interfaces	RS232, RS422, RS485 2 wire, RS485 4 wire			

Environmental

<i>Physical Parameter</i>	<i>Minimum</i>	<i>Typical</i>	<i>Maximum</i>	<i>Units</i>
Operating temperature range	-10		+50	°C
Storage temperature	-20		+70	°C
Humidity	0		95	%RH
Protection LCB20		IP0		
Protection LCA20		IP65		
Protection LSS		IP65		
Protection LDC		IP65		

Regulatory

CE Approvals

European EMC Directive

2004/108/EC

BS EN 61326-1:2006

BS EN 61326-2-3:2006

Low Voltage Directive

2006/95/EC

BS EN 61010-1:2001 Rated for Basic Insulation, Normal Condition, Pollution Degree 2, Permanently Connected, Insulation Category III

Troubleshooting

This chapter is designed to assist in the identification of problems relating to the installation and setting up of the LCA20.

General connection and setup parameters. - No display on power up.

- Check supply is present at the LCA20 terminals.
- If supply is correct contact distributor.

Display shows (-1 or 1) continually, without a weight applied to the Strain Gauge.

- Check input connections to the LCA20 from the Strain Gauge.
- If connecting a 4 wire device ensure terminals 1&2 and 5&6 are linked.
- Check Strain Gauge output between input terminals 3&4 of the LCA20.
- Check that the CALH weight is applied and is not the same or lower than CALL.

Display over ranges (-1 or 1) when, or before, the maximum required weight is applied to the Strain Gauge.

- Check that the **Sensitivity** parameter is set to the appropriate range in the menu.

Display very noisy

- If using a 4 wire device ensure terminals 1&2 & 5&6 are linked.
- Check output voltage of Strain Gauge.

Display operating in wrong direction

- Check connections to input terminals 3&4 are correct way round.
- Check the type of Strain Gauge - compression or tension.

Unit will not auto calibrate

- Check that CALH is not zero and its weight is greater than CALL.
- Check that input is not over-ranged on CALH weight.

Relay module: incorrect relay operation

- Check setpoint, in flight and hysteresis values are correct.
- Check latching and inversion settings are correct.
- Check connections to output terminals.

No communications

- Check that an LC4 communications module is fitted.
- Check LC4 Sw1 settings.
- Check correct CP code is entered for required protocol.
- Check serial device station number is correct.
- Check Baud rate setting in LCA20 menu is correct for the host.
- Check host communications port is set to 8 bit word, 1 start bit, 1 stop bit, no parity.
- Check correct protocol is being observed by the host.

Order Codes

Type	Description	Details	Code
Input	Standard Strain Gauge	5V DC Excitation @ 150mA	LCA20
Outputs	Standard Analogue	DC voltage 0-10V DC current 4-20mA	
Optional Modules			
Communications Port		Printer, RS232 & RS485	LC4
Output	Control/Alarm Relays	2 Relays SPCO on SP1 & 2	LR1
Power Supplies	AC and DC Power Supplies	110 - 240V AC 50 - 60Hz 10W	LS1
		9 - 32V DC 10W	LS3
Programming Units	On-board and handheld	On-board	LP1
		Remote Hand Held	LP2



LCA20 - LR1 - LC4 - LS1

Standard LCA20 in ABS case with relay module, communications module and 110/240 volts AC power supply

Accessories

Type	Description	Code
Enclosures	Diecast Enclosure	LDC
	Stainless Steel Enclosure	LSS
	DIN Rail Mount	D2
Programming Cable	Programming Cable	PGM1

Configuration Record Sheet

LCA15 Mode

Product
Product Code
Serial No.
Tag No.
Date
Location
Measurement type, range & engineering units
Calibration Date
Calibration Interval

Password Level 1

<i>Parameter</i>	<i>Value</i>
SP1	
IF1	
SP2	
IF2	
HYS	
OA	
CALL	
CALH	
At	
dA	
OPL	
OPH	
dP	
CP	
SdSt	
bAUd	
LAB	
Ln	
rS	

Password Level 2

<i>Parameter</i>	<i>Value</i>
FStP	
FLVL	
SEnS	
rAtE	
ADCL	
ADCH	
ZErO	
AOPS	

ddiS	
------	--

Password Level 3

<i>Parameter</i>	<i>Value</i>
dIP1	
dIP2	
dIP3	
RLS1	
RLS2	
ANOP	
4.20G	
4.20o	
0.10G	
0.10o	
OVrV	
undV	
tYPE	

LCA20

Product
Product Code
Serial No.
Tag No.
Date
Location
Measurement type, range & engineering units
Calibration Date
Calibration Interval

<i>Parameter</i>	<i>Value</i>
PASS	
tYPE	
VALS	
GroS	
nEt	
PEAK	
VALY	
SNAP	
mVV	
CALV	
rLYS	
rLY1	
SP1	
IF1	
HYS1	
InV1	
Ltc1	
rLS1	
rLY2	
SP2	
IF2	
HYS2	
InV2	
Ltc2	
rLS2	
AnOP	
OPL	
OPH	
AnOP	
AoPS	
InV	

<i>Parameter</i>	<i>Value</i>
Adj	
4 20G	
4 20o	
0 10G	
0 10o	
diSP	
dA	
dP	
rS	
ddiS	
PEAk	
VALY	
SNAP	
OVRV	
UndV	
LCiP	
FSTP	
FLVL	
SEnS	
rATE	
ACAL	
AdCL	
AdCH	
CALL	
CALH	
AT	
trbd	
ZEro	
SErL	
CP	
SdSt	
bAud	
LAb	
Ln	
diPS	
dIP1	
dIP2	
dIP3	

Warranty

All LCA products from Mantracourt Electronics Ltd., ('Mantracourt') are warranted against defective material and workmanship for a period of three (3) years from the date of dispatch.

If the 'Mantracourt' product you purchase appears to have a defect in material or workmanship or fails during normal use within the period, please contact your Distributor, who will assist you in resolving the problem. If it is necessary to return the product to 'Mantracourt' please include a note stating name, company, address, phone number and a detailed description of the problem. Also, please indicate if it is a warranty repair.

The sender is responsible for shipping charges, freight insurance and proper packaging to prevent breakage in transit.

'Mantracourt' warranty does not apply to defects resulting from action of the buyer such as mishandling, improper interfacing, operation outside of design limits, improper repair or unauthorised modification.

No other warranties are expressed or implied. 'Mantracourt' specifically disclaims any implied warranties of merchantability or fitness for a specific purpose. The remedies outlined above are the buyer's only remedies. 'Mantracourt' will not be liable for direct, indirect, special, incidental or consequential damages whether based on the contract, tort or other legal theory.

Any corrective maintenance required after the warranty period should be performed by 'Mantracourt' approved personnel only.



Designed, manufactured
and supported in the UK



In the interests of continued product development, Mantracourt Electronics Limited reserves the right to alter product specifications without prior notice.

DESIGNED & MANUFACTURED IN THE UK